



• ANTICO CASALE 90 GE Keramiek

Professionele keuken uitgerust met een maxi multifunctionele oven (9 functies).

Verkrijgbaar met kookplaat in meerdere uitvoeringen en met de mogelijkheid om een product "op maat" te laten maken dankzij de ruime keuze aan beschikbare bekledingen.

Het assortiment is verkrijgbaar in twee oplossingen: **metaal** , **keramiek** , om aan verschillende smaken en stijlen te voldoen.

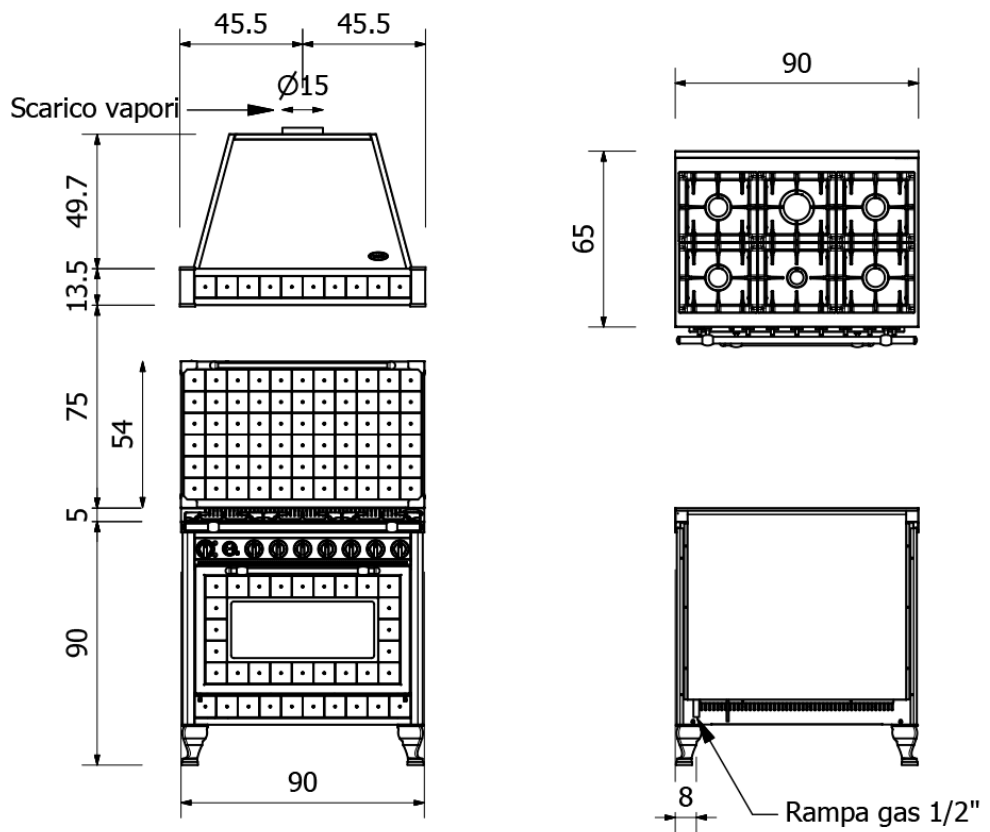

NETTO GEWICHT	170 kg
MAX POWER MULTIFUNCTIONELE ELEKTRISCHE OVEN	2,7 kW
MULTIFUNCTIONELE ELEKTRISCHE OVEN AFMETINGEN (B X H X D)	62 x 35 x 45 cm
MULTIFUNCTIONELE ELEKTRISCHE OVEN VOLUME	97 l

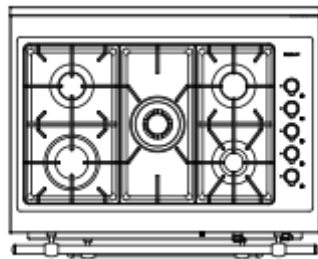

TOP 90 00

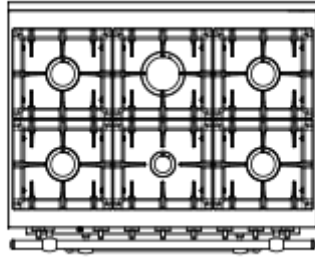

TOP 90 01

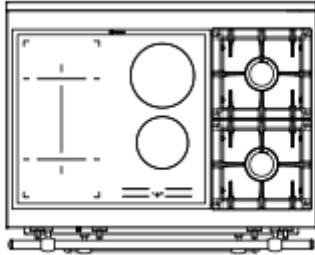

TOP 90 02

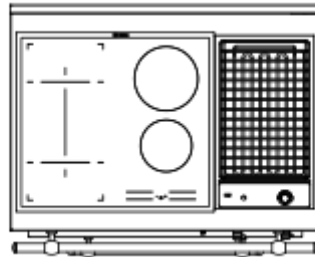

TOP 90 03

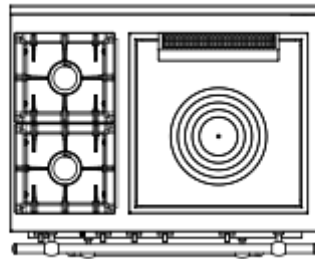

TOP 90 04

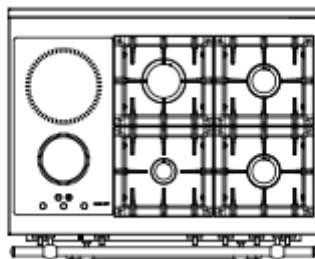

TOP 90 05

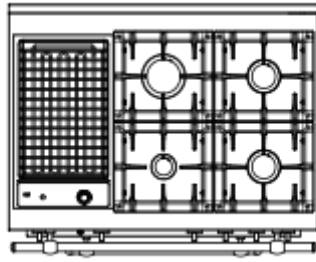

TOP 90 06

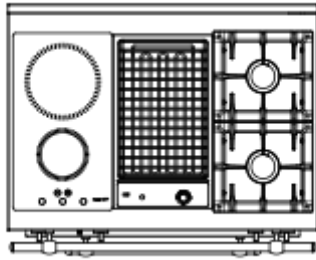

TOP 90 07

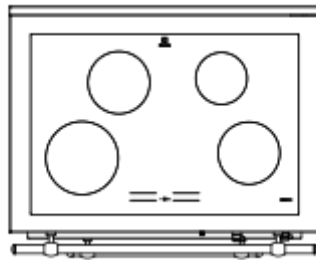

TOP 90 08

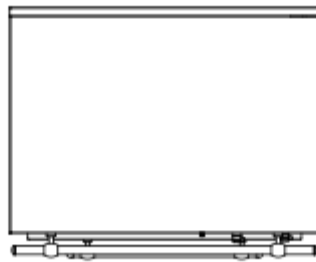

Aanpasbaar



8 × 8 KEUKENTEGELS

