

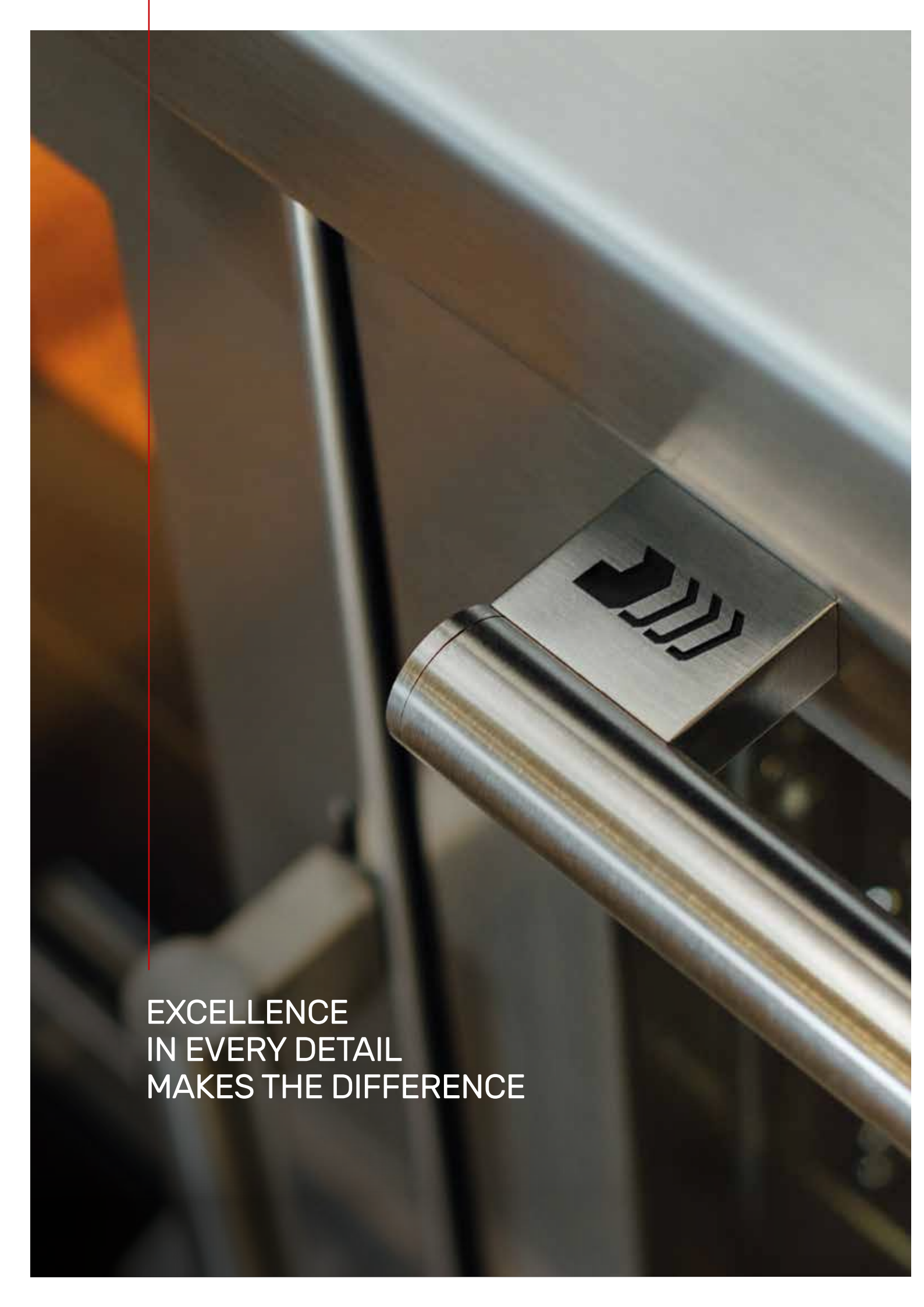

 **de manincor**  
il fuoco dal 1828



EXCELLENCE  
IN EVERY DETAIL  
MAKES THE DIFFERENCE



## **2 THE DE MANINCOR COMPANY**

VALUES, HISTORY, INNOVATION,  
DE MANINCOR PROFESSIONAL AND  
DE MANINCOR PROFESSIONAL VILLA

## **8 ENVIRONMENT**

ECO-SUSTAINABILITY AND  
ECOPLUS® SYSTEM

## **10 MATERIALS**

CAST IRON, FIREBRICKS,  
STAINLESS STEEL

## **12 ADVANTAGES**

THE 10 REASONS FOR CHOOSING  
DE MANINCOR

## **14 COOKERS**

WOOD-BURNING, THERMO, GAS, ELECTRIC

### **LINES**

- 16 DOMINO LINE
- 26 ECO LINE
- 34 CLASSIC LINE
- 48 COMBI
- 52 RUSTICA

## **54 HOODS**

## **58 THERMO-HEATING**

- 60 THERMO-COOKERS
- 70 THERMO-STOVES

## **76 STOVES**

## **77 FINISHES AND ACCESSORIES**

## **82 PROFESSIONAL WOOD-COOKERS FOR CATERING**

## **88 TECHNICAL DATA SHEETS**



OUR  
BRANDED  
VALUES



## FIRE

Since 1828, fire has fuelled our passion for craftsmanship, technology and entrepreneurship, pushing us toward continuous improvement.



## 5 GENERATIONS

For 5 generations, the old tradition of master blacksmiths has been translated into art, solidity and value, knowingly combining innovation and attention to detail.

## 100% MADE IN ITALY

Each of our products proudly bears the brand of Italian excellence and is made in our factory in Trento.



## RELATIONSHIP WITH THE CUSTOMER

We believe in lasting relationships, just like our cookers: listening and trust are the foundations of our work.

## TASTE FOR WORK DONE WELL

The attention paid to the smallest of details is the source of our satisfaction, in every stage of production, from the concept to the design right through to delivery.





# A HISTORY OF EXCELLENCE

## IN THE HEART OF TRENTINO SINCE 1828

From a small workshop, where horses used to be shod and small wrought iron artefacts used to be forged, to the first warehouse in Trento, straight to the present industrial establishment, our history proudly bears the signs of craftsmanship excellence of Trento. A history of fatigue, dedication and passion which ultimately led to the first DeManincor cooker: one of unique quality, destined to cross important milestones.

That cooker, distinguished by its solidity and superior efficiency, immediately entered many Italian homes: from the very beginning, our goal was not only to heat the homes but also people's heart. By combining creativity with technological innovation and craftsmanship, we have travelled along a journey of entrepreneurial development that has led us to become one of the most dynamic and innovative players in the Sector.

*With the same passion and craftsmanship as the beginning, today we are a modern technologically advanced, industrial company.*



## IN CONTINUOUS EVOLUTION SINCE 1828

Quality, solidity, reliability and attention to detail are the result of experience matured over more than 180 years. Technological, environmental and design requirements have changed significantly throughout this long period of time. We have followed and supported this evolution, and sometimes we have also managed to anticipate it and guide it.

We certainly did not stop at our achievements and our successes, rather, **we always relaunched and aimed forward.** Just like the past behind our brands reflects this well.







## OVER 180 YEARS OF COOKER ART

First, there was fire. With **DeManincor Casa** products we offer **traditional Italian cookers** intended for current times: not only wood-burning stoves, which represent the core of our history, but also thermo-cookers and thermo-stoves, electric and gas cookers, free-standing and suction hoods. With a distinctive feature: **craftsmanship** - matured over more than 180 years of experience. A guarantee of quality, warmth and emotion.





## EXCELLENCE IN FINE DINING

**DeManincor Professional** is our line dedicated to catering professionals. Maximum expression in **combined technology and design**, our professional cooking units have a peculiarity that makes them the **flagship of excellence** in the market: they are **unique examples**, custom-made according to the needs of great chefs and the most prestigious starred restaurants. Tailored perfection - the most advanced product deriving from a tradition renewed ever since 1828.



## UNIQUE ACHIEVEMENTS FOR LUXURY HOMES

We bring the experience matured alongside the great protagonists of catering into private homes. Our references in this sector make us ideal partners in designing and building **customised cooking units**, perfect in fulfilling the demands of even the most demanding gourmet enthusiasts. Thus, the unique designs of **DeManincor Professional Villa** are created: elegant jewels suitable for any living environment.





# SUSTAINABILITY IS IN OUR NATURE

Our company is founded in **Trentino**. Our forests and mountains have taught us a fundamental fact: **how to live in harmony with the balance of nature**. A lifestyle that immediately translated into a **business style**, marked by respect and attention: for the environment, the territory and the well-being of people.

#### **NON-POLLUTING AND 100% RECYCLABLE MATERIALS**

Eco-friendly materials are chosen.

#### **ONLY ITALIAN PARTNERS AND SUPPLIERS**

We only use Made in Italy materials for a product that is as local as possible.

#### **ECOLOGICAL COMBUSTION**

Our technologies make the most of the calorific value of wood, thereby minimising waste and CO<sub>2</sub> emissions.

#### **ATTENTION PAID TO THE ENTIRE VALUE CHAIN**

We care for every stage of production, always attentive to the quality of relationships with workers, partners and suppliers.





## THE ECOPLUS<sup>®</sup> SYSTEM

Our **ECOPLUS<sup>®</sup> System** represents the state of the art in the field of **ecological technologies for wood-burning combustion**. As a result of decades of research applied in this development sector, the ECOPLUS<sup>®</sup> System conveys the preheated secondary air over the flame, fuelling a **second combustion** that completely burns volatile gases and significantly reduces harmful emissions into the atmosphere. Such optimised double combustion allows for **better thermal performance**, with remarkable **fuel savings** and **enhanced autonomy**, thereby ensuring **greater efficiency over time** due to the reduced amount of residues produced.



**1.** The primary air, adjustable with the specific control, prepares the wood for combustion by drying and releasing the combustible gases contained therein.

**2.** The secondary air feeds the core of the combustion with a preheated air flow that flows over the flame, which ignites the gases released from the wood.





# ONLY MATERIALS OF FIRST CHOICE

DeManincor's excellence primarily derives from a thorough selection of the materials. The **excellent performance levels** guaranteed by all our products (in terms of performance, efficiency, solidity, safety and energy savings) are the result of a targeted business strategy, developed upstream of the production process: we only use **top quality** materials which are strictly of **Italian** origin. An industrial policy that is definitely challenging to sustain but which makes us very proud.

## CAST IRON

A distinguishing feature of the DeManincor range is the use of thick radiant cast iron hobs which, besides having unique heat diffusion properties and excellent thermal conductivity, are non-deformable at high temperatures.



## CERTIFIED FIREBRICKS

The combustion chamber is entirely covered with firebricks so as to ensure **optimal combustion and cleanliness.**



## STAINLESS STEEL

All DeManincor products are made of top quality thick steel: **18/10 Stainless Steel**, an alloy known for its excellent **mechanical strength** and high **anti-corrosion properties.**



## CERTIFICATION

Our industrial product quality choices are not only rewarded with excellent performance but also attested by numerous Certifications. All DeManincor wood-burning products have optimal thermal yield, certified according to EN12815 and EN13240. Efficiency, savings, safety and quality: these are the features that allow DeManincor wood-burning cookers to meet the limits set forth by the most stringent

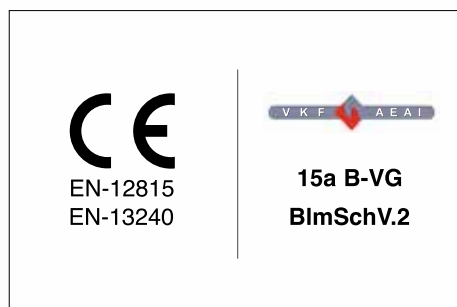

European emission standards (VKF, BlmSchV.2, 15a B-VG).



# 10 REASONS FOR CHOOSING DE MANINCOR

By choosing a DeManincor wood-burning stove you are choosing a product of unique qualities, with passion applied in every detail. The benefits are many: with only one product you warm up the environment naturally while ensuring optimal cooking and completing your home with an elegant furnishing element that respects the environment thanks to efficient and clean combustion. But there are many other reasons to choose a DeManincor cooker - find out below.



## OTHER PERFORMANCE

All DeManincor wood-burning products have optimal thermal yield exceeding 80%, certified according to EN12815 and EN13240.

1

2

## LOW EMISSIONS

The ECOPLUS® system optimises wood combustion, reducing harmful emissions in the atmosphere, thereby respecting national and international standards.



3



## GREAT AUTONOMY

Thanks to ECOPLUS® technology, the DeManincor wood-burning cookers and stoves have greater autonomy, which allows consumption to be reduced significantly

4

## HIGH POTENTIAL

DeManincor technology offers high power, ideal for quickly heating large areas too.





5

## STURDINESS

Using top quality materials guarantees robustness, strength and durability of all DeManincor products.



6

## QUALITY OF THE MATERIALS

All DeManincor products are made of 18/10 stainless steel, the hobs are made of cast iron and the combustion chamber is covered with firebricks.



7

## IMPECCABLE COOKING

The thick radiant cast iron hob and the firebrick oven ensure perfectly homogeneous cooking and high temperatures.



8

## SET-UP TO BE RECESSED

Customised plinth and various types of hob to facilitate the recess. Vented sides for natural convection. Spacers for maximum adaptability and safety.



9

## MADE-TO-MEASURE

The DeManincor team offers the possibility of customised applications to suit the specific needs of the living environment.



10

## MADE IN ITALY DESIGN

In the kitchen, Made in Italy is a guarantee of quality. All DeManincor products are designed and manufactured in Italy.



# COOKERS



## WOOD

Wood is a practical and renewable energy source, which provides a natural and economical heating system. Our ECOPLUS® system optimises combustion, thereby ensuring optimum energy efficiency and reducing harmful emissions in the atmosphere.



## THERMAL

Wood-burning thermo-heating is an ecological and efficient system that allows for heating, cooking and producing domestic hot water.



## GAS

We also offer matching gas hobs that we produce "in-house".



## ELECTRIC

Following the same principle, we also offer our customers the latest generation electric induction or infrared hobs.



# GENERAL CHARACTERISTICS

Our cookers have all or some of the following features, depending on the models.



Ecological combustion with ECOPLUS® System



External air intake



Set-up to be recessed

# THERMAL CHARACTERISTICS

Thermo-cookers have all or some of the following features, depending on the models.



Boiler with 5 year warranty



Boiler set up for thermal discharge



Set up for thermal discharge upon request



Integrated open cup  
Only EKB110



Domestic hot water on request  
Only EKB110

# COLOURS AND FINISHES

The cookers can be customised in colour and finishes based on preferences.



Red



Blue



Yellow



Green



Black



Ivory



White



Steel



Grey



Rust



Arte Series  
*(see page 69)*



RAL Colours



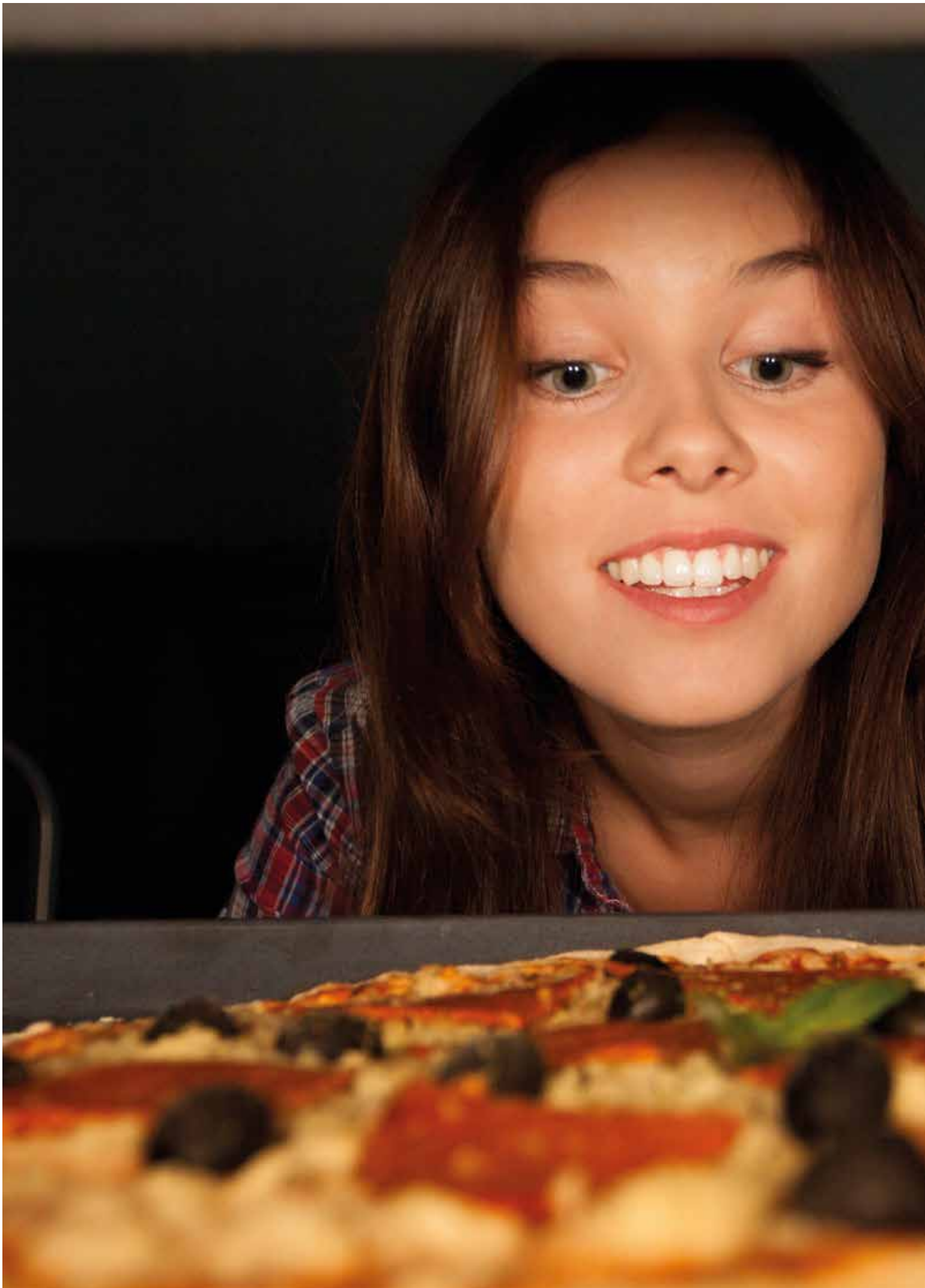

A woman with long brown hair, wearing a red, white, and blue plaid shirt, is seen from the side, looking towards a pizza. The pizza is in the foreground, slightly out of focus, showing a thick crust and toppings. The background is a kitchen setting with a dark wall and a red object, possibly a pizza oven or a sign, partially visible.

# DOMINO

## LINE

” *I admire the fire show, I warm the environment and cook perfect pizzas.*

*My DOMINO - I can only love her.*



**D8 MAXI**

BLACK STAINLESS STEEL DOORS





## THE FIRST, THE MOST LOVED

DOMINO, the wood-burning cooker is the perfect match between design, aesthetics and functionality. Perfect as a cooker but also as a powerful stove, with its modern and basic lines and its panoramic glass it conveys elegance and warmth to any environment, while offering top notch performance.

## DETAILS THAT MAKE ALL THE DIFFERENCE

### CAST IRON HOB

A distinctive element of DeManincor cookers is the thick radiant cast iron hob, which guarantees superior performance in terms of homogeneous heat diffusion.

### LARGE OVEN

Large, stainless steel oven with a double glazed window, light and a thermometer, ideal for homogeneous cooking and high temperatures up to 300°C.

### ECOPLUS® SYSTEM

State of the art for complete and clean combustion - it guarantees maximum thermal performance and reduces harmful emissions into the atmosphere.

### FIREBRICKS

They fully cover the combustion chamber and the flue so as to maintain a suitable temperature while achieving cleaner combustion and excellent oven performance.

### WIDE FIRE VIEW

The large ceramic window, equipped with a self-cleaning system, allows you to enjoy the fire, just like in front of a fireplace.

### GREAT AUTONOMY

The hearth and the large hopper accommodate logs longer than 40 cm.

### VENTED SIDES

The vented sides by natural convection guarantee the circulation of natural air, which is healthy, silent and evenly distributed.

### FLEXIBILITY TO BE RECESSED

Customised plinth and various types of hob to facilitate the recess.

### SMOKE OUTLET

Can be placed at the top right or left. On request, at the back or on the side.

# TECHNICAL CHARACTERISTICS

The technical features and attention to detail make DOMINO a wood-burning cooker of great resistance, power, autonomy and reliability. The standard equipment (such as the vented sides by natural convection and the ECOPLUS® System), coupled with the absolute quality of the materials, are the guarantee of excellent performance.

1. Thick radiant cast iron hob
2. Thick 18/10 stainless steel hob
3. Starter for cold start
4. Large ash pan
5. Oven moisture regulation valve
6. Glass fibre hermetic sealing
7. Wide ceramic window with self-cleaning system
8. Vented sides for natural convection
9. Oven with double glazed window, light and a thermometer
10. External air intake



11. ECOPLUS® system, primary air
12. Primary air adjustment lever
13. ECOPLUS® system, secondary air
14. Sturdy wood box
15. Combustion chamber and smoke path covered in firebricks

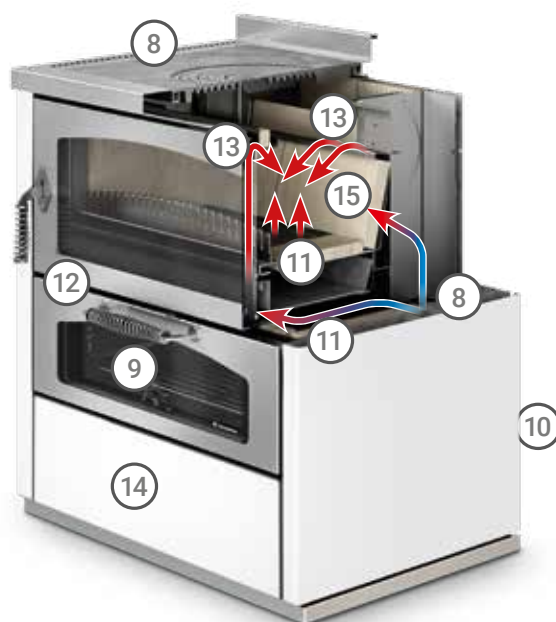





**D8 + GD7**

RED STAINLESS STEEL DOORS  
LOW HOOD

**DOMINA**

BLACK STAINLESS STEEL DOORS







## D8



Measurements: 80x60x86 cm  
 Nominal power: 7.5 (10) kw  
 Efficiency: 87%



## D8 MAXI



Measurements: 80x60x86 cm  
 Nominal power: 7.5 (10) kw  
 Efficiency: 87%



## D6



Measurements: 60x60x86 cm  
 Nominal power: 5.5 (7.5) kw  
 Efficiency: 85%



## D6 MAXI



Measurements: 60x60x86 cm  
 Nominal power: 5.5 (7.5) kw  
 Efficiency: 85%





GD7



Measurements: 70x60x86 cm



GD9



Measurements: 90x60x86 cm



## COMBINATA

For those looking for a complete cooker, a COMBINATA is ideal. Together with the wood-burning cooker, a module with a 4 or 5-burner gas or electric hob (induction or infrared), allows for several cooking methods.



**GD7+D8**  
BLACK DOOR VERSION



## DE MANINCOR ISLAND

WHITE STAINLESS STEEL DOORS  
KP FLAT HOOD  
COOKING SIDE: D6+GD9  
OPPOSITE SIDE: SINK  
+ CUPBOARD BASE



Oversized sink 70x40x20h cm flush with the counter also for 60 cm oven trays



Raised centre with compartments (bottle holders, tool holders, GN 1/9)



# ECO LINE

” *With its colour and modern lines, my ECO conveys warmth and emotion to my home.  
Ecological, practical and contemporary  
- perfect for my lifestyle.*







E90

BLACK STAINLESS STEEL DOORS





## YOUNG AND MODERN LINE

In the ECO wood-burning cooker, tradition and design blend so as to create a modern product: practical, fast and lightweight; in one word: smart. With its contemporary character it fits in any environment, delivering top performance both as a cooker and as a stove.

## DETAILS THAT MAKE ALL THE DIFFERENCE

### CAST IRON HOB

A distinctive element of DeManincor cookers is the thick radiant cast iron hob, which guarantees superior performance in terms of homogeneous heat diffusion.

### LARGE OVEN

Large, stainless steel oven fitted with light and a thermometer, ideal for homogeneous cooking and high temperatures up to 300°C.

### ECOPLUS® SYSTEM

State of the art for complete and clean combustion - it guarantees maximum thermal performance and reduces harmful emissions into the atmosphere.

### FIREBRICKS

They fully cover the combustion chamber and the flue so as to maintain a suitable temperature while achieving cleaner combustion and excellent oven performance.

### EXPOSED FIRE

The door with the large ceramic window, equipped with a self-cleaning system, allows you to enjoy the fire.

### VENTED SIDES

The vented sides by natural convection guarantee the circulation of natural air, which is healthy, silent and evenly distributed.

### FLEXIBILITY TO BE RECESSED

The features of this product (custom made plinth, sides, spacers) ensure great adaptability to the different installation contexts.

### GREAT AUTONOMY

The hearth and the large hopper accommodate logs measuring up to 35 cm long.

### SMOKE OUTLET

Can be placed at the top right or left. On request, at the back.

# TECHNICAL CHARACTERISTICS

The technical features and attention to detail make ECO a wood-burning cooker of great resistance, power, autonomy and reliability. The standard equipment, combined with the absolute quality of the materials, are the guarantee of excellent performance.

1. Thick radiant cast iron hob
2. Thick 18/10 stainless steel hob
3. Starter for cold start
4. Large ash pan
5. Glass fibre hermetic sealing
6. Wide ceramic window with self-cleaning system
7. Oven with lighting and a thermometer
8. Vented sides for natural convection
9. Sturdy wood box



10. ECOPLUS® system, primary air
11. Primary air thermostatic regulator
12. ECOPLUS® system, secondary air
13. External air intake
14. Combustion chamber and smoke path covered in firebricks

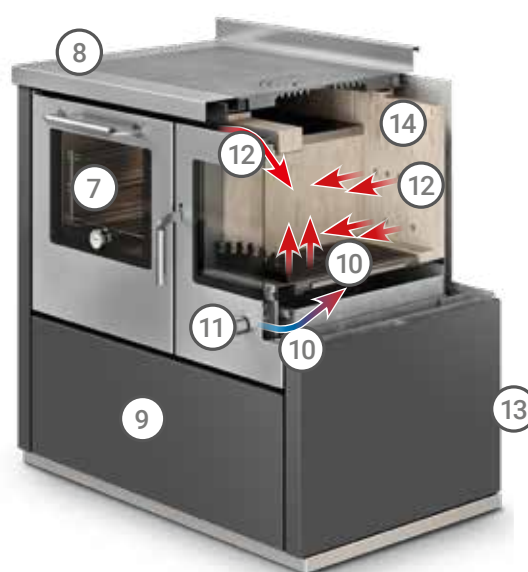





## E90



Measurements: 90x60x86 cm  
 Nominal power: 6 (7.5) kw  
 Efficiency: 85%



## E80



Measurements: 80x60x86 cm  
 Nominal power: 6 (7.5) kw  
 Efficiency: 85%



## E60



Measurements: 60x60x86 cm  
 Nominal power: 5 (6.5) kw  
 Efficiency: 83%



## E60F



Measurements: 60x60x86 cm  
 Nominal power: 5 (6.5) kw  
 Efficiency: 89.5%



**GD9 + E80**

WHITE STAINLESS STEEL DOORS  
FLAT HOOD





# COMBINATA

For those looking for a complete cooker, a COMBINATA is ideal. Together with the wood-burning cooker, a module with a 4 or 5-burner gas or electric hob (induction or infrared), allows for several cooking methods.



## E90P



Measurements: 90x60x86 cm  
Nominal power: 6 (7.5) kw  
Efficiency: 85%



Ceramic colours:  
White, Bordeaux



E90 + GD7



E90P  
CERAMIC BORDEAUX





# CLASSICA LINE

” *Respect for the roots  
is crucial  
when looking to the future.  
CLASSICA allows me to find  
my philosophy of life,  
of simple things,  
genuine and long-lasting.*





**F90**

BLACK STAINLESS STEEL  
FLAT HOOD

## THE WARMTH OF TRADITION

CLASSICA derives from the great history of DeManincor wood-burning cookers - it is the perfect combination of classicism and modernity. A product of excellent performance, both as a stove and as a wood-burning cooker, ideal for adding a touch of traditional warmth in your home.

## DETAILS THAT MAKE ALL THE DIFFERENCE

### CAST IRON HOB

A distinctive element of DeManincor cookers is the thick radiant cast iron hob, which guarantees superior performance in terms of homogeneous heat diffusion.

### ECOPLUS® SYSTEM

State of the art for complete and clean combustion - it guarantees maximum thermal performance and reduces harmful emissions into the atmosphere.

### FLEXIBILITY TO BE RECESSED

Customised plinth and various types of hob to facilitate the recess. Vented sides for natural convection that allow for insertion between furniture without any further precautions (requiring only a distance of 3mm).

### WIDE FIRE VIEW

The large fire door, with a triple-glazed ceramic window equipped with a self-cleaning system, allows you to enjoy the fire.

### FIREBRICKS

They fully cover the combustion chamber and the flue so as to maintain a suitable temperature while achieving cleaner combustion and excellent oven performance.

### LARGE OVEN

Large stainless steel oven with a double glazed window, fitted with light, a thermometer and removable tray holder guides, ideal for homogeneous cooking and high temperatures up to 300°C.

### GREAT AUTONOMY

The hearth and the large hopper accommodate logs measuring up to 35 cm long.

### SMOKE OUTLET

Can be placed at the top right or left. On request, at the back or on the side. The height of the rear smoke outlet is easily adjustable.

# TECHNICAL CHARACTERISTICS

The technical features and attention to detail make CLASSICA a wood-burning cooker of great resistance, power, autonomy and reliability. The standard equipment (such as the vented sides by natural convection and the ECOPLUS® System), coupled with the absolute quality of the materials, are the guarantee of excellent performance.

1. Thick radiant cast iron hob
2. Thick 18/10 stainless steel hob
3. Starter for cold start
4. Large ash pan
5. Glass fibre hermetic sealing
6. The large fire door with a triple-glazed ceramic window equipped with a self-cleaning system,
7. Vented sides for natural convection
8. Oven with double glazed window, fitted with light and a thermometer
9. Removable tray holder guides
10. Practical access to clean the flue
11. Sturdy wood box on buffered guides
12. ECOPLUS® system, primary air
13. Primary air adjustment lever
14. ECOPLUS® system, secondary air
15. External air intake
16. Combustion chamber and smoke path covered in firebricks
17. Plinth adjustable in height and depth

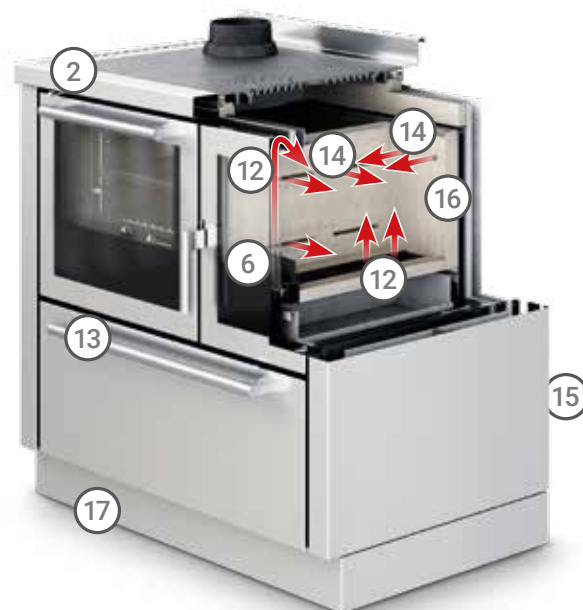



**F70**  
STAINLESS STEEL DOORS  
FLAT HOOD



**G90 MAXI + F80**

ARTE 14 BLACK  
HIGH HOOD





## F110



Measurements: 110x60x86 cm  
 Nominal power: 5,5 (7,5) kw  
 Efficiency: 85%



## F100



Measurements: 100x60x86 cm  
 Nominal power: 5,5 (7,5) kw  
 Efficiency: 85%



## F90



Measurements: 90x60x86 cm  
 Nominal power: 5,5 (7,5) kw  
 Efficiency: 85%



## F80



Measurements: 80x60x86 cm  
 Nominal power: 5,5 (7,5) kw  
 Efficiency: 85%





**F80 + G60**

WHITE S.STEEL BLIND DOORS  
LOW HOOD





## F110



Measurements: 110x60x86 cm  
 Nominal power: 5,5 (7,5) kw  
 Efficiency: 85%



## F100



Measurements: 100x60x86 cm  
 Nominal power: 5,5 (7,5) kw  
 Efficiency: 85%



## F90



Measurements: 90x60x86 cm  
 Nominal power: 5,5 (7,5) kw  
 Efficiency: 85%



## F80



Measurements: 80x60x86 cm  
 Nominal power: 5,5 (7,5) kw  
 Efficiency: 85%





# F70



Measurements: 70x60x86 cm  
Nominal power: 4.5 (6.5) kw  
Efficiency: 85%



# F60



Measurements: 60x60x86 cm  
Nominal power: 4.5 (6.5) kw  
Efficiency: 85%



# F50



Measurements: 50x60x86 cm  
Nominal power: 4.5 (6.5) kw  
Efficiency: 87.5%



# F40



Measurements: 40x60x86 cm  
Nominal power: 4.5 (6.5) kw  
Efficiency: 87.5%







F70



Measurements: 70x60x86 cm  
 Nominal power: 4.5 (6.5) kw  
 Efficiency: 85%



F60



Measurements: 60x60x86 cm  
 Nominal power: 4.5 (6.5) kw  
 Efficiency: 85%



F50



Measurements: 50x60x86 cm  
 Nominal power: 4.5 (6.5) kw  
 Efficiency: 87.5%



F40



Measurements: 40x60x86 cm  
 Nominal power: 4.5 (6.5) kw  
 Efficiency: 87.5%



# TECHNICAL CHARACTERISTICS

As a leader in the sector of professional cookers, together with the wood-burning power, DeManincor offers the combination with **gas cookers** with **4 or 5 burners**, one of which with a triple crown, with heavy duty flush mount cast iron grills. Alternatively you can opt for the **induction or infrared hobs with 4 or 5 zones**.

Static/ventilated multifunction 60 or 90 cm electric oven. The 60 cm G910 model is equipped with a practical storage compartment, whereas the 90 cm maxi G910 oven is complete with the spit.

The finishes, plinth and profile of the hob have the same characteristics as those of classic wood-burning cookers.

Optional: stainless steel griddle hob.



**G90 MAXI**  

Measurements: 90x60x86 cm

 Arte 14 version  
Red



**G60**  

Measurements: 60x60x86 cm





**G60**  

Measurements: 60x60x86 cm







**G90**

BLACK STAINLESS STEEL DOOR  
LOW HOOD





# COMBI

Thanks to the construction of the COMBI models, we can offer an end product with unique features, tailored to your specific requirements. The work top reflects DeManincor excellence: a single thick 18/10 stainless steel sheet, with no joints and junctions - a guarantee of functionality and superior hygiene. A complete and advanced system that offers more than just the individual simplicity of individual parts.

**COMBI 180**

LOW HOOD





## MB120



F60 + G60 4 burners

Measurements: 120x60x86 cm



Arte 14  
Red



## MB140



F80 + G60 4 induction zones

Measurements: 140x60x86 cm



## MB156



F60 + G90 maxi 4 burners

Measurements: 150x60x86 cm



Arte 12  
White







## MB159



F90 + G60 4 burners

Measurements: 150x60x86 cm



Arte 11  
Ivory



## MB170



F80 + G90 5 burners

Measurements: 170x60x86 cm



Arte 13  
Grey



## MB180



F90 + G90 maxi 5 induction zones

Measurements: 180x60x86 cm



Arte 12  
Blue





# FP100



FP100 plaster  
Measurements: 100x60x86 cm





 Arte 14  
Black



# FP100



FP100  
Measurements: 100x60x86 cm





 Arte 12  
Black



# FG100



FG100  
Measurements: 100x60x85 cm





 Arte 14  
Black





## F91



F91

Measurements: 90x60x54 cm



Black



## FP90



FP90 plaster

Measurements: 90x60x86 cm



Arte 12  
Black



## FG90



FG90

Measurements: 90x60x85 cm



Arte 14  
Black









# HOODS

THE PERFECT COMPLETION OF A  
CLEAN AND EFFICIENT COOKER



**K180**  
HIGH HOOD



## EFFICIENT AND ELEGANT HOODS

A hood is much more than an accessory, it is the guarantee of a clean, hygienic and functional cooker. Solid, resistant and of stylish design, the DeManincor hoods perform different functions simultaneously, ensuring the cooker always has the ideal atmosphere.

## DETAILS THAT MAKE ALL THE DIFFERENCE

### **EXCELLENT RESISTANCE**

Special epoxy powder coating for increased resistance to steam, grease and heat.

### **PROFESSIONAL EXTRACTION**

Powerful extractor of variable speed and low noise.

### **HIGH AIR INTAKES**

900-1200 m<sup>3</sup>/hour, ideal for efficient air exchange in the room.

### **ANTI-GREASE FILTERS**

Stainless steel filters easily washable, even in the dishwasher.

### **MAXIMUM COMFORT**

Standard built-in lighting with LED lights and ladle holder bar.



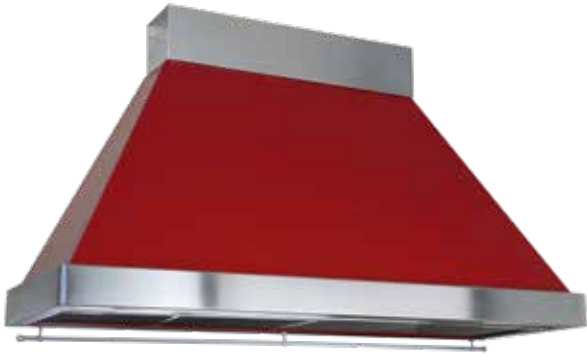

**K** High hood



**KD** RH/LH diagonal hood



**KA** Low hood



**KP** Flat hood \*



**KAI** Recessed hood \*

## MEASUREMENTS

Standard models: from 90 to 200 cm

Recessed: 90-120-150 cm

## FINISHES

Cover: stainless steel, black, white, red,  
blue, green, yellow, ivory

Beams: stainless steel, brass

\* They do not have the standard ladle holder.

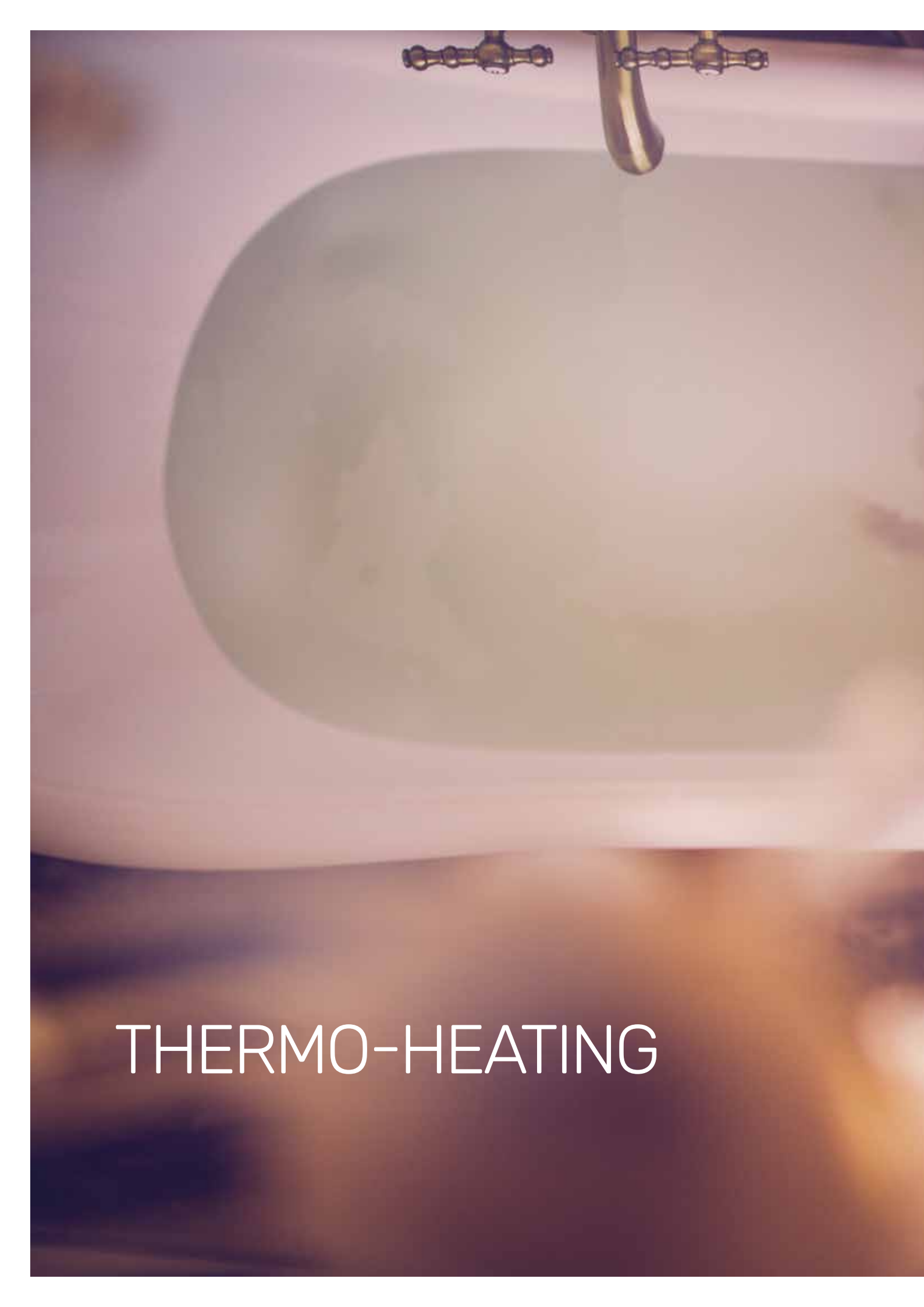

THERMO-HEATING

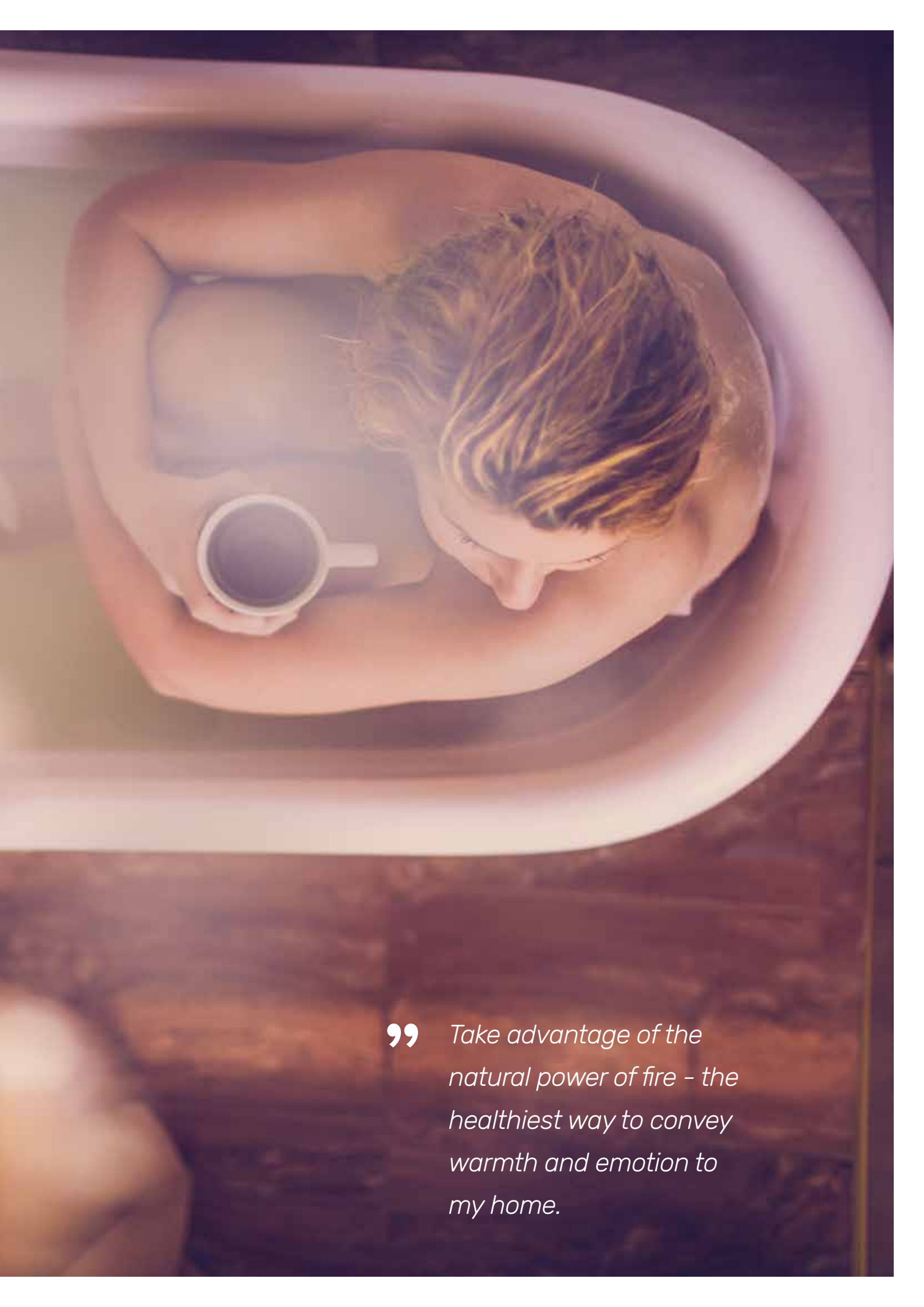

” *Take advantage of the natural power of fire – the healthiest way to convey warmth and emotion to my home.*



**FKA900 + G910**

ARTE 14 RED  
HIGH HOOD



# THERMO-COOKERS

*I cook and warm the  
environment  
while respecting the  
ecosystem.*

*I take care of the home  
and the environment  
with my THERMO-COOKER.*



# THERMO-COOKERS

DeManincor THERMO-COOKERS have represented robustness, durability and efficiency for years. They are the right choice for those who want to enjoy all the advantages of a modern thermo-cooker, while benefiting from the healthy heat of fire.

## DETAILS THAT MAKE ALL THE DIFFERENCE

### BOILER WITH 5 YEAR WARRANTY

Boiler with exchange surfaces designed to achieve maximum performance, in special thick steel, with a 5-year warranty.

### LARGE OVEN

Large stainless steel oven, fitted with light and a thermometer, ideal for homogeneous cooking and high temperatures up to 250°C.

### CAST IRON HOB

A distinctive element of DeManincor cookers is the thick radiant cast iron hob, which guarantees superior performance in terms of homogeneous heat diffusion.

### SMOKE OUTLET

Can be placed at the top right or left. On request, at the back or on the side.

### ECOPLUS® SYSTEM

State of the art for clean combustion - it guarantees maximum thermal performance and reduces harmful emissions

### FIREBRICKS

They fully cover the flue so as to maintain a suitable temperature while achieving cleaner combustion and excellent oven performance.

### FLEXIBILITY TO BE RECESSED

The features of this product (custom made plinth, various hobs, spacers) ensure great adaptability to the different installation contexts.

## OPEN CUP SYSTEM

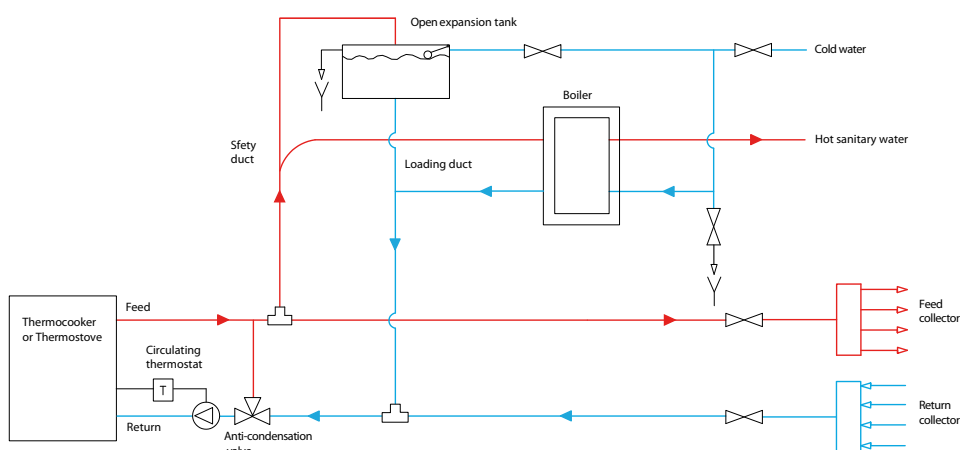



1. Thick radiant cast iron hob
2. Thick 18/10 stainless steel frame
3. Starter for cold start
4. Cast iron fire door with glass fibre hermetic sealing
5. Boiler thermometer
6. Height adjustable grill (FK900 and FK600)
7. Glass fibre hermetic sealing
8. Oven with lighting and a thermometer
9. Sturdy wood box



10. ECOPLUS® system, primary air
11. Primary air thermostatic regulator
12. ECOPLUS® system, secondary air
13. Double connections to facilitate installation
14. Smoke path covered in firebricks
15. Boiler with 5-year warranty

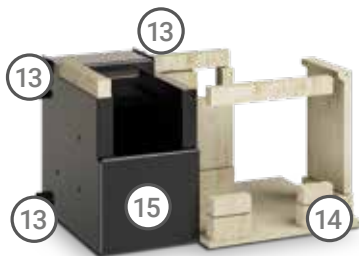
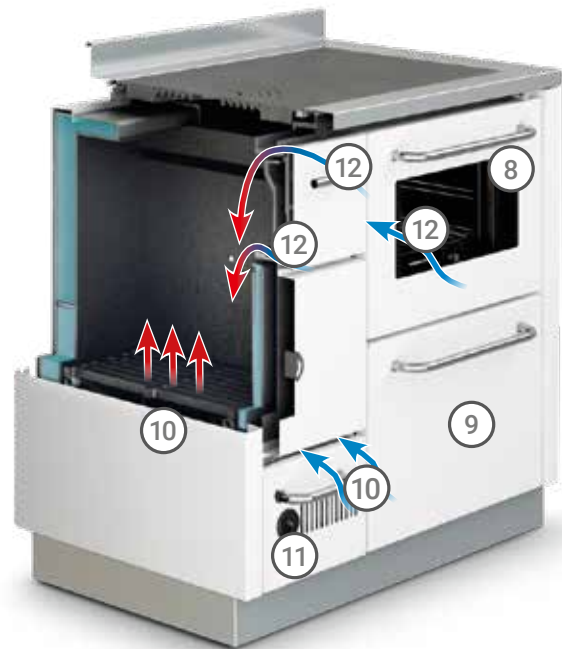

## CLOSED CUP SYSTEM

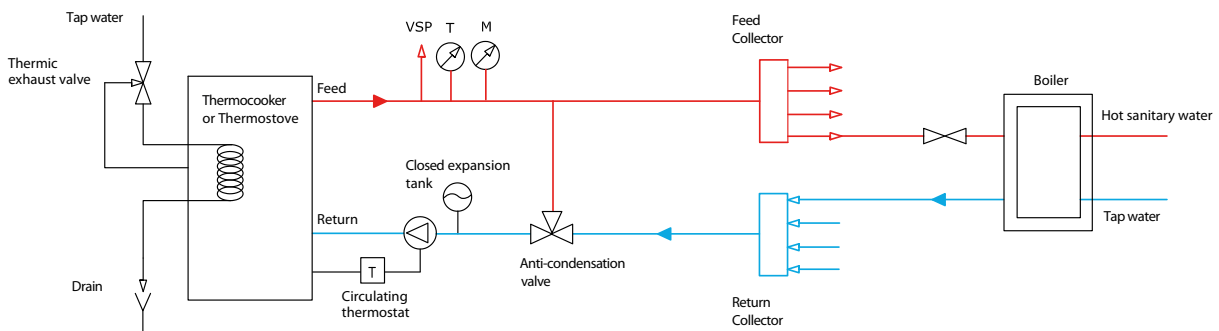

M= Manometer VSP= Over-pressure valve T= Thermometer



## FK900



Measurements: 90x60x86 cm  
 Nominal power: 14 (22) kw  
 Efficiency: 70%



Enamel: ● ○ ● ○



## FK600



Measurements: 60x60x86 cm  
 Nominal power: 14 (22) kw  
 Efficiency: 70%



Enamel: ● ○ ● ○



## FKA900



Measurements: 90x60x86 cm  
 Nominal power: 12 (20) kw  
 Efficiency: 70%



● ● ● ● ● ○ ● ● ○

\*not available in the arte 14 version



## EK90



Measurements: 90x60x86 cm  
 Nominal power: 12 (20) kw  
 Efficiency: 70%



● ● ● ● ● ○ ● ● ○

**THERMO-COOKER EK90**

IVORY BLACK DOORS





# THERMO-COOKERS INTEGRATED OPEN CUP

Our integrated open cup THERMO-COOKERS are easily harmonised with the hydraulic system, avoiding invasive and costly interventions. They are designed to guarantee a simple and safe installation, even in combination with other pre-existing systems.

## DETAILS THAT MAKE ALL THE DIFFERENCE

### **SIMPLE AND SAFE INSTALLATION**

Thanks to the integrated open cup, no other safety systems are required and the cooker can be connected directly to a closed cup system.

### **BOILER WITH 5 YEAR WARRANTY**

Boiler with exchange surfaces designed to achieve maximum performance, in special thick steel, with a 5-year warranty.

### **ECOPLUS® SYSTEM**

State of the art for complete and clean combustion - it guarantees maximum thermal performance and reduces harmful emissions into the atmosphere.

### **SMOKE OUTLET**

Upper right or upon request, rear.

### **CAST IRON HOB**

A distinctive element of DeManincor cookers is the thick radiant cast iron hob, which guarantees superior performance in terms of heat diffusion.

### **FIREBRICKS**

They fully cover the combustion chamber and the flue so as to maintain a suitable temperature while achieving cleaner combustion and excellent oven performance.

### **LARGE OVEN**

Large stainless steel oven, fitted with light and a thermometer, ideal for homogeneous cooking and high temperatures up to 250°C.

### **HSW - HOT WATER**

A secondary coil available on demand allows the production of instant Hot Sanitary Water (13 Lt / min).



1. Thick radiant cast iron hob
2. Thick 18/10 stainless steel hob
3. Starter for cold start
4. Height adjustable grill
5. Large ash pan
6. Glass fibre hermetic sealing
7. Wide ceramic window with self-cleaning system
8. Oven fitted with light and a thermometer
9. Electronic control unit set up for three-way valve control
10. 2 integrated circulators: one for the internal circuit and one for the thermo-hydraulic circuit
11. ECOPLUS® system, primary air
12. Primary air thermostatic regulator
13. ECOPLUS® system, secondary air
14. Smoke path covered in firebricks
15. Sturdy wood box
16. Practical access to clean the flue
17. Coil thermal exchange system
18. Integrated safety open cup

## INTEGRATED OPEN CUP SYSTEM

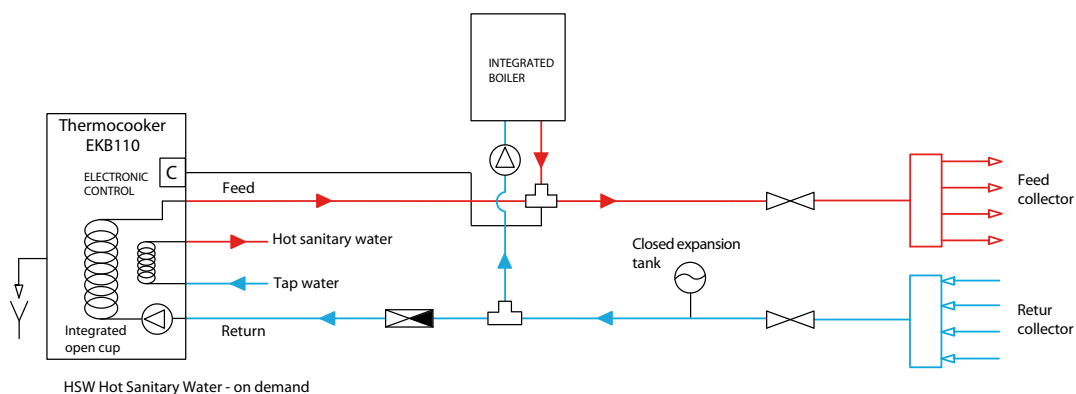



Safety system with integrated open cup. The overflow system allows controlling the water level.



Two integrated pumps: one for the inner circuit, one for the heating circuit.



The exchange of heat takes place through a system of coils immersed in the tank.



The combustion chamber in refractory material guarantees excellent performance and the long life of the exchanger.

## ELECTRONIC CONTROL UNIT



The electronic control unit guarantees advanced control of the heating system, the safety alarms and the maintenance functions.

### MAIN FUNCTION

Detects the boiler temperature and adjusts the integrated circulation pump.

### SECONDARY FUNCTION

Management of external devices connected with the thermo-cooker.

### ALARM FUNCTION

When the boiler temperature exceeds the set value, a sound and visual alarm are activated.

### LEVEL STATE FUNCTION

A visual alarm is triggered if the water level in the boiler is low.

### STANDBY FUNCTION

If the temperature exceeds the safety temperature while the control unit is switched off, the pump goes on automatically.

### ANTI-FREEZE FUNCTION

If the temperature drops below a certain level, the circulation pump is activated.



## EKB110



Measurements: 110x60x86 cm

Nominal power: 17,5(25) kw

Efficiency: 85%







**THERMO-COOKER EKB110+GD7**

BLACK STAINLESS STEEL DOORS  
LOW HOOD





# THERMO-STOVES

” *My THERMO-STOVE is placed elegantly in my living room, giving the house warmth and emotion. While respecting the environment.*



ZK60F  
BLACK





# HEALTHY HEAT OF FIRE

The exclusive DeManincor technology has combined high power and great autonomy with refined and elegant aesthetics. Resulting in our THERMO-STOVES being capable of delivering high level performance while respecting the environment. A modern, practical, clean and efficient furnishing element.

## DETAILS THAT MAKE ALL THE DIFFERENCE

### **ECOPLUS® SYSTEM**

State of the art for complete and clean combustion - it guarantees maximum thermal performance and reduces harmful emissions into the atmosphere.

### **OPTIMAL PERFORMANCE**

DeManincor technology combines high power and great autonomy, thereby ensuring performance of up to 85%.

### **FIREBRICKS**

They cover the bottom of the combustion chamber, thereby ensuring high performance and significantly reduced boiler condensation, thereby guaranteeing greater efficiency over time.

### **EXTERNAL AIR INTAKE**

The air used by the combustion is not drawn from the internal environment but entirely from the outside.

### **BOILER WITH 5 YEAR WARRANTY**

Boiler with exchange surfaces designed to achieve maximum performance, in special thick steel, with a 5-year warranty.

### **SET UP FOR SAFETY THERMAL DISCHARGE**

Equipped with inside exchange circuit for closed implants with security heat exhaust.

### **LARGE OVEN**

Large stainless steel oven with a double glazed window, fitted with a thermometer, ideal for homogeneous cooking and high temperatures up to 250°C.

### **VERY POWERFUL**

The large combustion chamber allows to reach high powers useful for heating even large spaces.



Practical access to clean the flue above the oven



External air intake diameter 80 mm Ø



Oven door with double glazed window and a thermometer



Oven base made of food-safe refractory material

1. Shell and tube boiler designed for the best performance
2. Upper smoke outlet diameter 15mm (Ø)
3. ECOPLUS® system, primary air
4. Primary air thermostatic regulator
5. ECOPLUS® system, secondary air
6. Refractory material coating
7. Easy cleaning
8. External air intake diameter 80mm (Ø)
9. Large ash pan
10. Wood compartment

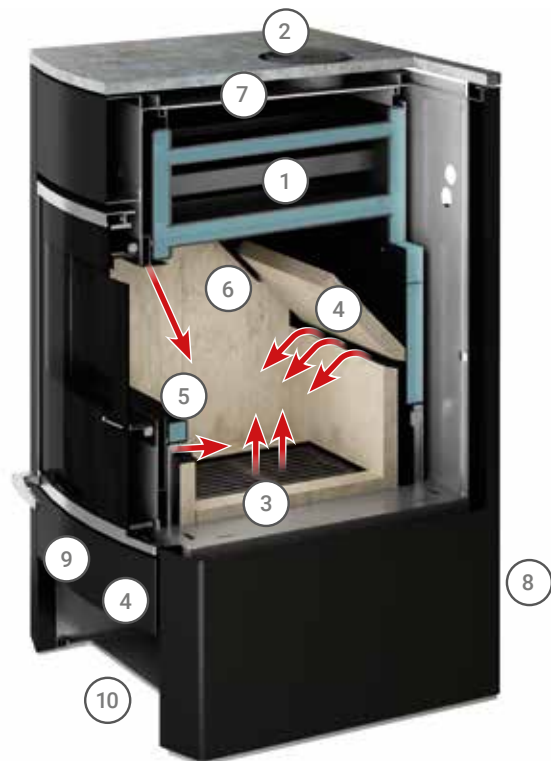



## ZK60



Measurements: 68x66x108 cm  
Nominal power: 13.9 (24.5) kw  
Efficiency: 85%



## SK60



Measurements: 68x66x108 cm  
Nominal power: 13.9 (24.5) kw  
Efficiency: 85%



Ceramic colours:  
White, Earth, Bordeaux



## ZK60F



Measurements: 68x66x145 cm  
Nominal power: 17.1 (26.5) kw  
Efficiency: 85%



## SK60F



Measurements: 68x66x145 cm  
Nominal power: 17.1 (26.5) kw  
Efficiency: 85%



Ceramic colours:  
White, Earth, Bordeaux





**SK60F**  
BORDEAUX CERAMIC

# STOVES

## DETAILS THAT MAKE ALL THE DIFFERENCE

### ECOPLUS® SYSTEM

State of the art for complete and clean combustion - it guarantees maximum thermal performance and reduces harmful emissions into the atmosphere.

### OPTIMAL PERFORMANCE

DeManincor technology combines high power and great autonomy, thereby ensuring performance of up to 85%.

### FIREBRICKS

They cover the bottom of the combustion chamber, thereby ensuring high performance and significantly reduced boiler condensation, thereby guaranteeing greater efficiency over time.

### EXTERNAL AIR INTAKE

The air used by the combustion is not drawn from the internal environment but entirely from the outside.

### LARGE OVEN

Large stainless steel oven with a double glazed window, fitted with a thermometer, ideal for homogeneous cooking and high temperatures up to 250°C.

### VERY POWERFUL

The large combustion chamber allows to reach high powers useful for heating even large spaces.



Z60F



Measurements: 68x66x145 cm  
Nominal power: 13.5 (16) kw  
Efficiency: 85%



S60F



Measurements: 68x66x145 cm  
Nominal power: 13.5 (16) kw  
Efficiency: 85%



Ceramic colours:  
White, Earth, Bordeaux

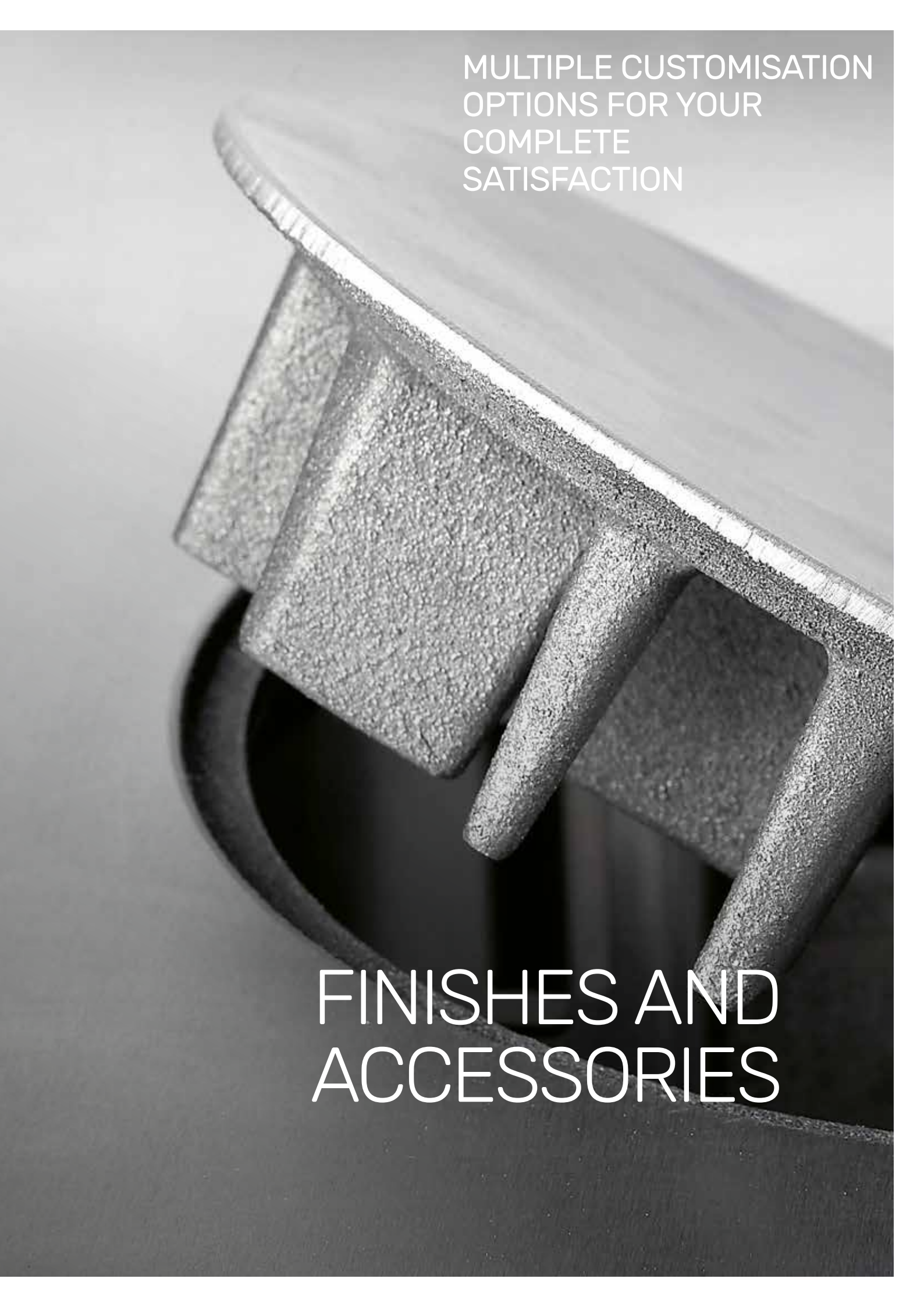

A close-up, black and white photograph of a metal component, likely a part of a machine or tool. The component has a complex, angular shape with a prominent, textured surface that appears to be a fine-grained or sandblasted finish. The lighting creates strong highlights and shadows, emphasizing the three-dimensional form and the texture of the material. The background is a plain, light-colored surface.

MULTIPLE CUSTOMISATION  
OPTIONS FOR YOUR  
COMPLETE  
SATISFACTION

FINISHES AND  
ACCESSORIES



# HANDLES

## DOMINO



D1  
Stainless steel



D3  
Stainless steel

## CLASSICA



D5  
Stainless steel

# DOORS

## DOMINO



Stainless steel



Black

## ECO

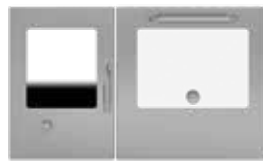

Stainless steel

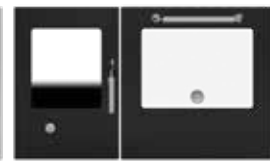

Black

## CLASSICA

Stainless steel

Black

Arte Version

Triple-glazed door

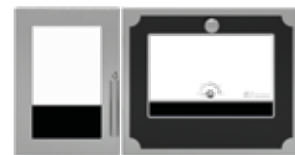

Solid doors

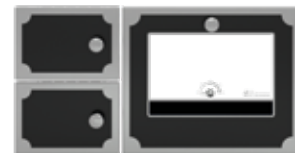

# CLASSICA THERMO-COOKER FINISHES

As a covering and waterproof coating, the enamel is applied on the surfaces to provide the product with additional resistance and protection against rust and acidic action.



Brass



Stainless Steel



White enamel



Black enamel



Satin finish stainless steel



Faded brown

Only for thermo-cookers  
(FK600 e FK900)

# ARTE SERIES (A)

ARTE SERIES finishes and knobs allow you to further customize the product, giving it original character.

Arte 11	Arte 12	Arte 13	Arte 14	
				Black
				Grey
				White
				Ivory
				Red
				Blue
				Green
				Rust



RAL Colours  
[www.coloriral.com](http://www.coloriral.com)



Polished stainless steel



Brass



Satin finish stainless steel

# ACCESSORIES

We offer a wide range of accessories to complete the cooker according to your specific requirements. The match between design and top-quality materials, a characteristic of the DeManincor style, always guarantees high results in terms of solidity, resistance and functionality.



Stainless steel or brass handrail.



Griddle hob for gas cookers.



High performance radiant disc.



Stainless steel hob cover.



Glass ceramic hob for wood-burning cooker.



Pair of tray holder sliding guides.  
supplied on Classica, upon request  
on all the others.



# EXTERNAL AIR INTAKE

For installations in particularly hermetic environments, such as low energy homes or passive homes, it may be necessary to draw the combustion air directly from outdoors. Our models, equipped with an external air intake, can be easily connected.

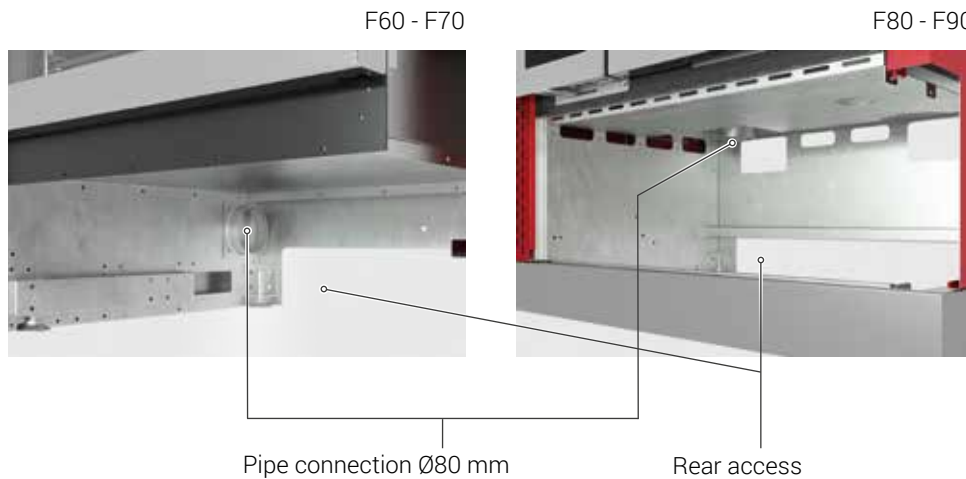

# THERMAL INSULATION AND SPACERS

If it is necessary to move the cooker near materials that are particularly sensitive to heat, an adequate safe distance must be maintained. A distance of 3 mm is sufficient for the Classica line models. Specific spacers are available for all other models, set up to be recessed, which allow for simple and safe installation.

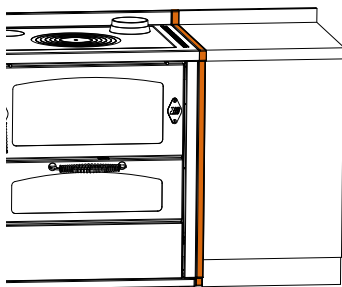

Custom spacer: stainless steel hob, front panel and plinth.

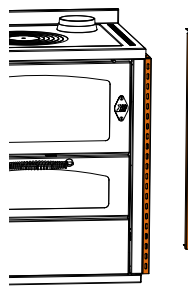

Pierced spacer.

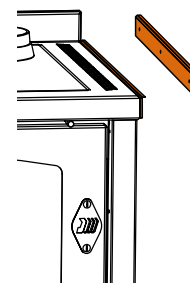

Hob profile.



# PROFESSIONAL WOOD-COOKERS FOR CATERING

” *With my DeManincor wood-burning  
cooker, traditional  
dishes are enhanced with  
that unique flavour that  
my clients seek.*





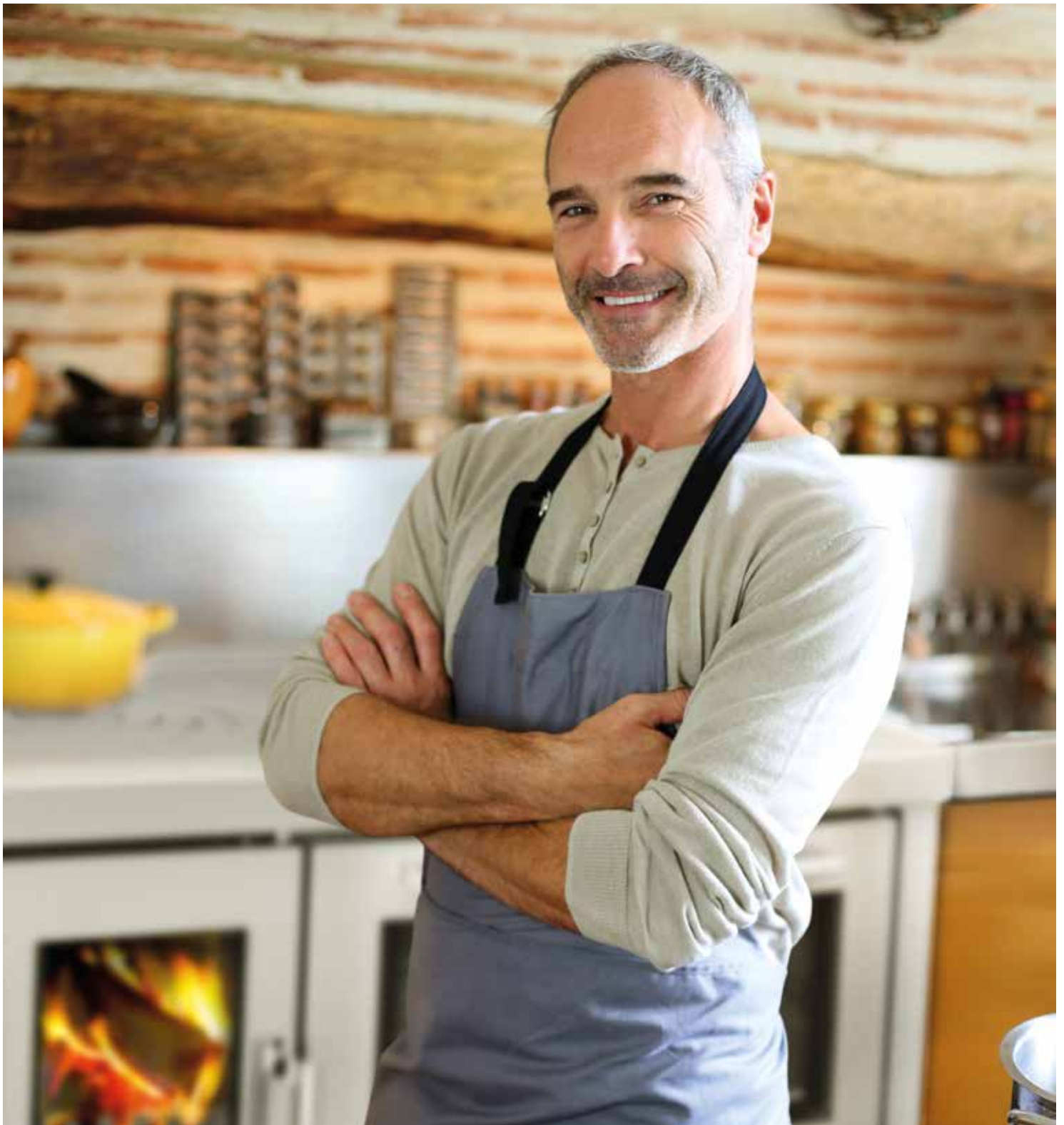

## PROFESSIONAL WOOD-BURNING COOKERS

Solid, practical and functional, DeManincor cookers are used in restaurants, taverns and lodges, providing warmth and traditional wood-cooking. The large stainless steel oven, together with the excellent quality of the materials and the high performance in terms of autonomy and power, make DeManincor wood-burning cookers a winning choice for catering professionals: a choice that is always rewarded with customer appreciation.

# DETAILS THAT MAKE ALL THE DIFFERENCE

## CAST IRON HOB

A distinctive element of DeManincor cookers is the thick radiant cast iron hob, which guarantees superior performance in terms of homogeneous heat diffusion.

## ECOPLUS® SYSTEM

State of the art for complete and clean combustion - it guarantees maximum thermal performance and reduces harmful emissions into the atmosphere.

## LARGE OVEN

Stainless steel oven measuring 54x56xh28 cm, compatible with Gastronorm Gn 1/1 trays, with a double glazed window, fitted with light and a thermometer, ideal for homogeneous cooking and high temperatures.

## WIDE FIRE VIEW

The large ceramic window, equipped with a self-cleaning system, allows you to enjoy the fire, just like in front of a fireplace.

## GREAT AUTONOMY

The hearth and the large hopper accommodate logs longer than 40 cm.

## FIREBRICKS

They fully cover the combustion chamber and the flue so as to maintain a suitable temperature while achieving cleaner combustion.



The solid door version is available upon request.

## FLEXIBILITY TO BE RECESSED

Customised plinth and various types of hob to facilitate the recess.

## EXTERNAL AIR INTAKE

The air used by the combustion is not drawn from the internal environment but entirely from the outside.



## LM110



Measurements: 110x70x91 cm

Nominal power: 7.5 (10) kw

Efficiency: 75%









# DETAILS THAT MAKE ALL THE DIFFERENCE

## CAST IRON HOB

A distinctive element of DeManincor cookers is the thick radiant cast iron hob, which guarantees superior performance in terms of homogeneous heat diffusion.

## ECOPLUS® SYSTEM

State of the art for complete and clean combustion - it guarantees maximum thermal performance and reduces harmful emissions into the atmosphere.

## LARGE OVEN

Stainless steel oven measuring 54x66x29 cm, compatible with Gastronorm Gn 2/1 trays, with a double glazed window, fitted with light and a thermometer, ideal for homogeneous cooking and high temperatures.

## UNDER OVEN

with maintenance function 54x66x24 cm compatible with Gastronorm Gn 2/1 trays. With window, upon request.



## GREAT AUTONOMY

The hearth and the large hopper accommodate logs longer than 60 cm.

## FIREBRICKS

They fully cover the combustion chamber and the flue so as to maintain a suitable temperature while achieving cleaner combustion.

## EXTERNAL AIR INTAKE

The air used by the combustion is not drawn from the internal environment but entirely from the outside.



## LM140



Measurements: 140x80x91 cm

Nominal power: 18 (25) kw

Efficiency: 85%



# TECHNICAL DATA SHEETS

## WOOD-BURNING COOKERS

DOMINO line		D6	D8	D6 MAXI	D8 MAXI
Efficiency		85%	87%	85%	87%
Nominal heat output (Max)	kw	5.5 (7.5)	7.5 (10)	5.5 (7.5)	7.5 (10)
CO measured (at 13% oxygen)	%	0.08	0.10	0.08	0.10
Recommended amount of wood	kg/h	1,5-2	2-2,5	1,5-2	2-2,5
External dimensions (LxWxH)	cm	60x60x86	80x60x86	60x60x86	80x60x86
Oven dimensions (LxWxH)	cm	34x47x15	54x47x15	34x47x26	54x47x26
Hearth dimensions (LxW)	cm	38x25x25	57x25x25	38x25x25	57x25x25
Hopper dimensions (LxH)	cm	35x20	55x20	35x20	55x20
Cooking hob (LxW)	cm	45x48	66x48	45x48	66x48
Net weight/with packaging	kg	180/195	195/215	180/195	195/215
Upper RH or LH smoke outlet (Ø)	cm	13	13	13	13
A) Side distance	cm	17	17.5	17	17.5
B) Wall distance	cm	14.4	14.8	14.4	14.8
Rear and RH or LH smoke outlet (Ø)	cm	13	13	13	13
C) Height	cm	72	72	72	72
D) Side outlet wall distance	cm	13	13	13	13
E) Rear outlet side distance	cm	15	15	15	15
Necessary chimney depression	mbar	0.12	0.12	0.12	0.12
External air intake (Ø) 80 mm		yes	yes	no	no
S.steel back panel and wood holder		DOMINA			
Recessed safe distance*	mm	25	25	25	25

Accessories upon request: front stainless steel/brass handrail, 2 or 3 sides, high performance disc, stainless steel hob cover

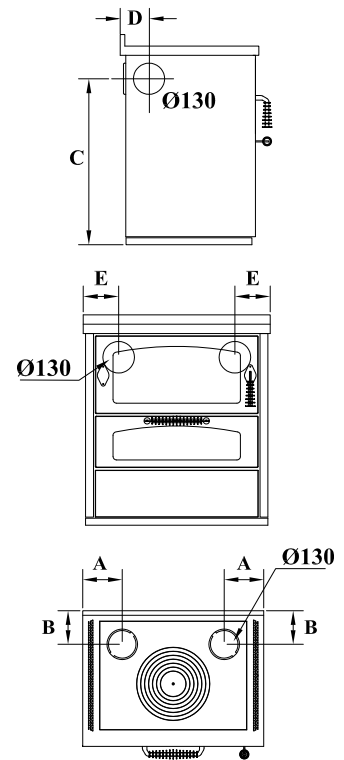

ECO line		E60	E60F	E80	E90
Efficiency		83%	89,5%	85%	85%
Nominal heat output (Max)	kw	5 (6.5)	5 (6.5)	6 (7.5)	6 (7.5)
CO measured (at 13% oxygen)	%	0.06	0,07	0.09	0.09
Recommended amount of wood	kg/h	1.7-2.5	1.6-2.5	1.8-2.5	1.8-2.5
External dimensions (LxWxH)	cm	60x60x86	60x60x86	80x60x86	90x60x86
Oven dimensions (LxWxH)	cm	-	24x44x26	36x43x26	36x43x26
Hearth dimensions (LxWxH)	cm	30x29x31	21x40x31	21x40x31	21x40x31
Hopper dimensions (LxH)	cm	36x22	16x25	16x25	22x25
Cooking hob (LxW)	cm	48x45	53x47	68x45	74x45
Net weight/with packaging	kg	130/140	140/155	165/180	175/190
Upper RH or LH smoke outlet (Ø)	cm	13	13	13	13
A) Side distance	cm	17	14.5	15.5	17.5
B) Wall distance	cm	14.5	16.5	16.5	16.5
Rear and RH or LH smoke outlet (Ø)	cm	13	13	13	13
C) Height	cm	72	72	72	72
D) Rear outlet side distance	cm	16	12.5	16	16
Necessary chimney depression	mbar	0.12	0.12	0.12	0.12
External air intake (Ø) 80 mm		yes	yes	yes	yes
Recessed safe distance*	mm	25	25	25	25

Accessories upon request: front stainless steel handrail, 2 or 3 sides, high performance disc, stainless steel hob cover

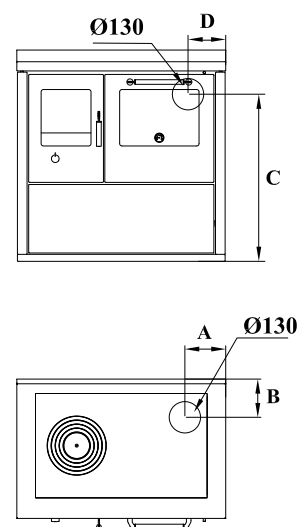

\*Side safe distance from inflammable material below the hob level.

CLASSICA line		F40	F50	F60	F70	F80	F90	F100	F110
Efficiency		87.5%	87.5%	85%	85%	85%	85%	85%	85%
Nominal heat output (Max)	kw	4,5 (6,5)	4,5 (6,5)	4,5 (6,5)	4,5 (6,5)	5,5 (7,5)	5,5 (7,5)	5,5 (7,5)	5,5 (7,5)
CO measured (at 13% oxygen)	%	0,09	0,09	0,09	0,09	0,10	0,10	0,10	0,10
Recommended amount of wood	kg/h	1,2-1,8	1,2-1,8	1,4-2	1,4-2	1,7-2	1,7-2	1,7-2	1,7-2
External dimensions (LxWxH)	cm	40x60x86	50x60x86	60x60x86	70x60x86	80x60x86	90x60x86	100x60x86	110x60x86
Oven dimensions (LxWxH)	cm	-	-	35x42x14	35x42x14	35x42x23	35x42x23	55x41x23	55x41x23
Hearth dimensions (LxW)	cm	17x35x24	17x35x24	21x37x27	21x37x27	17x37x23	17x37x23	19x35x24	19x35x24
Hopper dimensions (LxH)	cm	17x23	17x23	20x18	20x18	22x17	22x17	19x23	19x23
Cooking hob (LxW)	cm	34x49	34x49	53x47	53x47	73x47	73x47	93x47	93x47
Net weight/with packaging	kg	140/155	145/160	160/175	165/180	180/200	185/205	235/255	240/260
Upper RH or LH smoke outlet (Ø)	cm	13	13	13	13	13	13	13	13
A) Side distance	cm	central	central	14.5	19.5	14.5	19.5	14.5	19.5
B) Wall distance	cm	13,6	13,6	17.5	17.5	17.5	17.5	17.5	17.5
Rear and RH or LH smoke outlet (Ø)	cm	13	13	13	13	13	13	13	13
C) Height	cm	72	72	72	72	72	72	72	72
D) Side outlet wall distance	cm	14,5	14,5	16	16	16	16	16	16
E) Rear outlet side distance	cm	13,6	18,6	13	18	13	18	13	18
Necessary chimney depression	mbar	0,12	0,12	0,12	0,12	0,12	0,12	0,12	0,12
External air intake (Ø) 80 mm		yes	yes	yes	yes	yes	yes	yes	yes
Recessed safe distance*	mm	15	3	15	3	3	3	3	3

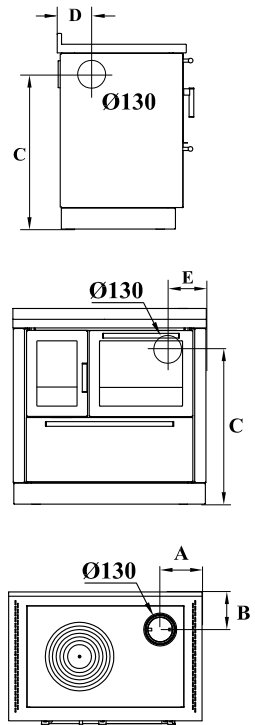

Accessories upon request: front stainless steel/brass handrail, 2 or 3 sides, high performance disc, stainless steel hob cover

\*Side safe distance from inflammable material below the hob level.

## EXTERNAL AIR INTAKE CONNECTION Ø 80mm

 Area where the external air intake connection can be set

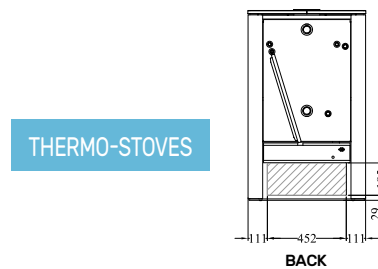
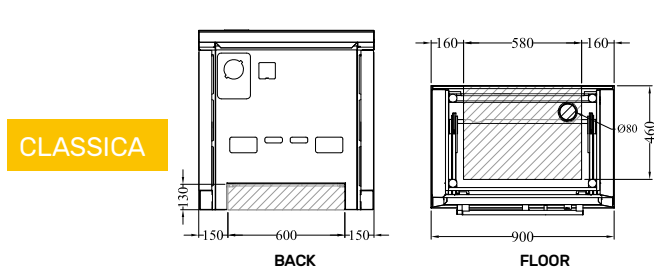
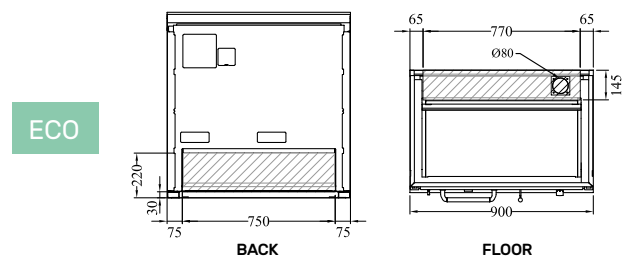
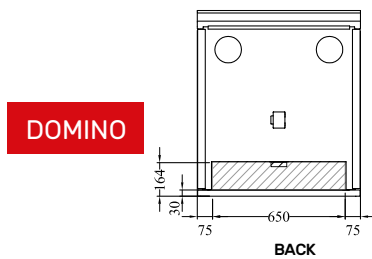



# GAS / ELECTRIC COOKERS

GAS AND ELECTRIC COOKERS		cm	G90	G60	GD9	GD7	INDUCTION HOBS	
			90x60x86	60x60x86	90x60x86	70x60x86	*4 zones	*5 zones
External dimensions (LxWxH)		cm	90x60x86	60x60x86	90x60x86	70x60x86	*4 zones	*5 zones
Small gas burner		kw 0.75	1	1	1	1		
Medium gas burner		kw 1.75	2	1	2	1		
Large gas burner		kw 3	1	1	1	1		
Triple crown gas burner		kw 3.6	1	1	1	1		
Cooking electric zone	Ø 16	kw 1.4					2	2
Cooking electric zone	Ø 16	kw 1.4/2					1	1
Cooking electric zone	Ø 20	kw 2.3					1	1
Cooking double zone	Ø 25	kw 2.3/3					-	1
Electric oven 2.2 kw (LxWxH)		cm	46x42x33	46x42x33		46x42x33	46x42x33	46x42x33
Electric oven 2.5 kw (LxWxH)		cm	62x41x31		62x41x31			62x41x31
Net weight/with packaging		kg	80/95	60/73	80/95	65/78		
Gas nominal power		kw	10.85	9.1	10.85	9.1		
Electric nominal power		kw	2.2/2.5	2.2	2.5	2.2	9	9.3/9.5
Electrical connection (A, B)			6-74	6-72	6-74	6-72		
Gas connection (C, D)			7-72	7-73	7-72	7-73		
Accessories upon request: front stainless steel/brass handrail, 2 or 3 sides, stainless steel griddle								

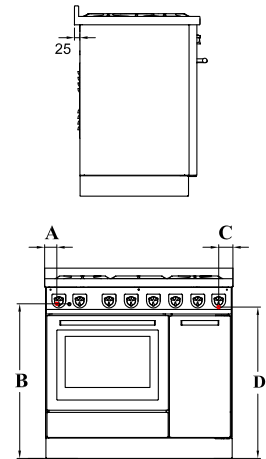

\*4 zones: G60 - GD7

\*5 zones: G90/G90 MAXI - GD9

# PROFESSIONAL WOOD-BURNING FOR CATERING

PROFESSIONAL WOOD-BURNING		LM110	LM140
Efficiency		75%	85%
Nominal heat output (Max)	kw	7.5 (10)	18 (25)
CO measured (at 13% oxygen)	%	0.11	0.02
External dimensions (LxWxH)	cm	110x70x91	140x80x91
Hearth dimensions (LxWxH)	cm	22x44x36	30x50x35
Oven dimensions (LxWxH)	cm	54x56x28	54x66x29
2 <sup>nd</sup> oven dimensions (LxWxH)	cm	-	54x66x24
Hopper (LxH)	cm	22x25	27x27
Cooking radiant hob (LxW)	cm	93x52	123x58
Net weight/with packaging	kg	270/290	520/540
Upper RH or LH smoke outlet (Ø)	cm	15	18
A) Side distance	cm	18	21
B) Wall distance	cm	15	23
RH or LH side and rear smoke outlet (Ø)	cm	15	18
C) Height	cm	76	70
D) Side outlet wall distance	cm	15	20
E) Rear outlet side distance	cm	16	17
Necessary chimney depression	mbr	0.12	0.12
External air intake (Ø) 80 mm		yes	yes
Accessories upon request: front stainless steel handrail, 2 or 3 sides, high performance disc*, stainless steel hob cover (*only LM110)			

# WOOD STOVES

WOOD STOVES		S60F	Z60F
Energy Efficiency Class		A+	A+
Efficiency		85%	85%
Nominal heat output (Max)	kw	13,5 (16)	13,5 (16)
CO measured (at 13% oxygen)	%	0,05	0,05
Recommended amount of wood	kg/h	2-5	2-5
External dimensions (LxWxH)	cm	68x66x145	68x66x145
Hearth dimensions (LxWxH)	cm	33x36x45	33x36x45
Oven dimensions (LxWxH)	cm	35x52x24	35x52x24
Hopper dimensions (LxH)	cm	35x25	35x25
Net weight/with packaging	kg	270/290	270/290
Upper smoke outlet (Ø)	cm	15	15
Necessary chimney depression	mbr	0,12	0,12
External air intake (Ø) 80 mm		si	si

# THERMO-HEATING

THERMO-COOKERS		FK600*	FK900	FKA900	EK90	EKB110*
Efficiency		70%	70%	70%	70%	85%
Nominal heat output (Max)	kw	14 (22)	14 (22)	12 (20)	12 (20)	17,5(25)
Nominal water output (Max)	kw	10.5 (18)	10.5 (18)	9 (16)	9 (16)	8,8(15)
CO measured (at 13% oxygen)	%	0.23	0.23	0.23	0.23	0,9
Recommended amount of wood (heating)	kg/h	4-5	4-5	4-5	4-5	4-5
Recommended amount of wood (cooking)	kg/h	2-2.5	2-2.5	2-2.5	2-2.5	2-2.5
External dimensions (LxWxH)	cm	60/80x60x86	90/110x60x86	90/110x60x86	90x60x86	110x60x86
Hearth dimensions (LxWxH)	cm	25x45x22/50	25x45x22/50	22x41x45	22x41x45	22x41x45
Oven dimensions (LxWxH)	cm	-	36x45x26	36x45x26	36x43x26	36x43x26
Hopper (LxH)	cm	21x17	21x17	21x23	22x25	22x25
Cooking radiant hob (LxW)	cm	43x45	74x45	74x45	74x45	74x45
Net weight/with packaging	kg	170/185	230/250	230/250	195/210	225/245
Upper RH or LH smoke outlet (Ø)	cm	14	14	14	14	14
D) Side distance	cm	16	17.5	17.5	17.5	17.5
E) Wall distance	cm	16	18	16.5	16.5	16.5
RH or LH side and rear smoke outlet (Ø)	cm	14	14	14	14	14
A) Height	cm	65	65	65	72	72
B) Side outlet wall distance	cm	17	17	17	-	-
C) Rear outlet side distance	cm	13	16	16	16	16
Necessary chimney depression	mbar	0.12	0.12	0.12	0.12	0.12
Maximum operating pressure	bar	2.5	2.5	1.5	1.5	2.5
Boiler content	lt	20	20	20	20	48
Boiler fittings (Ø)		1"1/4 / 3/4"	1"1/4 / 3/4"	1"1/4 / 3/4"	1"1/4	3/4"
External air intake (Ø) 80 mm		no	no	yes	no	yes
Domestic Hot Water Production		no	no	no	no	upon request

Accessories upon request: Front stainless steel/brass handrail, 2 or 3 sides, High performance disc, Stainless steel hob cover

\*smoke outlet only on the RH

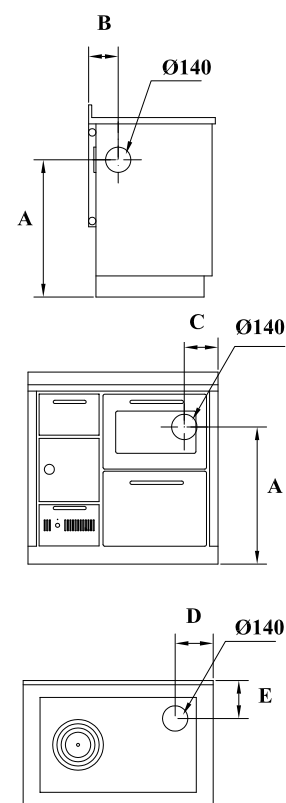

THERMO-STOVES		ZK60	SK60	ZK60F	SK60F
Efficiency		85%	85%	85%	85%
Nominal heat output (Max)	kw	13,9 (24,5)	13,9 (24,5)	17,1 (26,5)	17,1 (26,5)
Water heat output (Max)	kw	12,5 (20,5)	12,5 (20,5)	13,4 (20,5)	13,4 (20,5)
CO measured (at 13% oxygen)	%	0.06	0.06	0.06	0.06
Recommended amount of wood	kg/h	5-10	5-10	5-10	5-10
External dimensions (LxWxH)	cm	68x66x108	68x66x108	68x66x145	68x66x145
Oven dimensions	cm	-	-	35x52x24	35x52x24
Combustion chamber	lt	83	83	83	83
Hopper (LxH)	cm	35x25	35x25	35x25	35x25
Net weight	kg	260	260	320	320
Upper smoke outlet	Ø	15	15	15	15
Necessary chimney depression	mbar	0.12	0.12	0.12	0.12
Maximum operating pressure	bar	2.5	2.5	2.5	2.5
Boiler content	lt	26.5	26.5	26.5	26.5
External air intake (Ø) 80 mm		yes	yes	yes	yes
Boiler hydraulic connections (Ø)					
1) Delivery connection				1"1/4 female	
2) Connection for the thermal discharge circuit				1/2" male	
3) Return connection				1"1/4 female	
4) Thermal discharge probe connection				1/2" female	
5) Connection for the thermal discharge circuit				1/2" male	
6) Boiler discharge				1/2" female	
7) Pump thermostat				-	

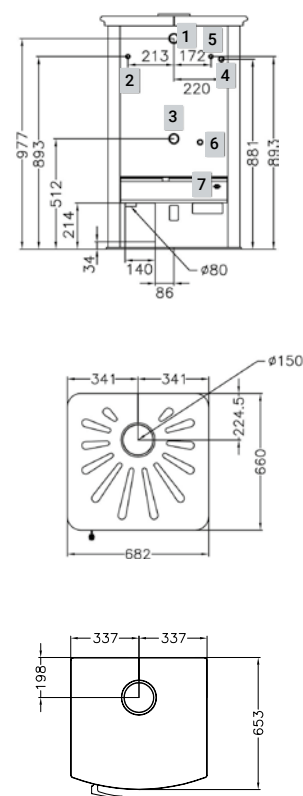

# HOODS

LOW HOOD and DIAGONAL RH/LH		KA90 - KD90	KA120 - KD120	KA150 - KD150
Max flow rate	m <sup>3</sup> /hour	900	900	900
4-speed motor	w	320	320	320
LED lighting	no.	2	2	3
Outlet (Ø)	cm	15	15	15
Stainless steel anti-grease filters	no.	2	3	3
Dimensions (LxWxH)	cm	90x50x45	120x50x45	150x50x45
		<b>KA170 - KD170</b>	<b>KA180 - KD180</b>	<b>KA200 - KD200</b>
Max flow rate	m <sup>3</sup> /hour	900	1200	1200
4-speed motor	w	320	450	450
LED lighting	no.	3	4	4
Outlet (Ø)	cm	15	20	20
Stainless steel anti-grease filters	no.	3	4	4
Dimensions (LxWxH)	cm	170x53x47	180x53x47	200x53x47

HIGH HOOD and FLAT HOODS		K90 - KP90	K120 - KP120	K150 - KP150
Max flow rate	m <sup>3</sup> /hour	900	900	900
4-speed motor	w	320	320	320
LED lighting	no.	2	2	3
Outlet (Ø)	cm	15	15	15
Stainless steel anti-grease filters	no.	2	3	3
Dimensions K (LxWxH)	cm	90x53x98	120x53x98	150x53x98
Dimensions KP (LxWxH)	cm	90x50x12	120x50x15	150x53x15
		<b>K170 - KP170</b>	<b>K180 - KP180</b>	<b>K200 - KP200</b>
Max flow rate	m <sup>3</sup> /hour	900	1200	1200
4-speed motor	w	320	450	450
LED lighting	no.	3	4	4
Outlet (Ø)	cm	15	20	20
Stainless steel anti-grease filters	no.	3	4	4
Dimensions K (LxWxH)	cm	170x53x98	180x53x98	200x53x98
Dimensions KP (LxWxH)	cm	170x50x15	180x50x15	200x50x15

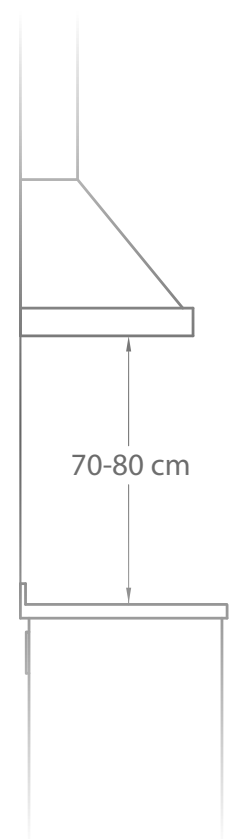

RECESSED HOODS		KAI90	KAI120	KAI150
Max flow rate	m <sup>3</sup> /hour	900	900	900
4-speed motor	w	320	320	320
LED lighting	no.	2	2	3
Outlet (Ø)	cm	15	15	15
Stainless steel anti-grease filters	no.	2	2	3
Hole for recess	cm	74.5x37.5	98.5x37.5	128.5x37.5
Dimensions (LxWxH)	cm	77x40x30	101x40x30	131x40x30



---

# DISCOVER THE RANGE OF DE MANINCOR WOOD-BURNING STOVES AND THE POSSIBLE COMBINATIONS



## DOMINO LINE



D8 red



D8 black



D8 grey



D8 rust



D8 ivory

## ECO LINE



E90 red



E90 black



E90 grey



E90 rust



E90 ivory

## CLASSICA LINE



F90 red



F90 black



F90 grey



F90 rust



F90 ivory



Version  
solid doors



Version  
solid doors



Version  
solid doors



Version  
solid doors



Version  
solid doors



Version  
ARTE 14



Version  
ARTE 14



Version  
ARTE 13



Version  
ARTE 12



Version  
ARTE 14



D8 white



D8 blue



D8 green



D8 inox



D8 yellow



E90 white



E90 blue



E90 green



E90 inox



F90 white



F90 blue



F90 green



F90 inox



Version  
solid doors



Version  
solid doors



Version  
solid doors



Version  
solid doors



Version  
ARTE 13



Version  
ARTE 12



Version  
ARTE 11





CONFIGURE  
YOUR  
COOKER



 **de manincor**  
fabbrica cucine dal 1828

DeManincor SpA  
Via di Spini, 15  
38121 Trento | ITALY  
tel. +39 0461 990 322  
fax +39 0461 990 234  
[www.demanincor.com](http://www.demanincor.com)  
[woodcookers.demanincor.com](http://woodcookers.demanincor.com)